

Finite Models

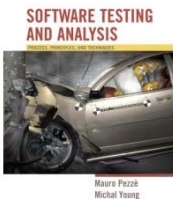

Learning objectives

- Understand goals and implications of finite state abstraction
- Learn how to model program control flow with graphs
- Learn how to model the software system structure with call graphs
- Learn how to model finite state behavior with finite state machines

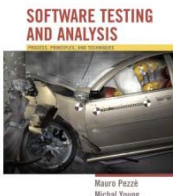

Properties of Models

- **Compact:** representable and manipulable in a reasonably compact form
 - What is *reasonably compact* depends largely on how the model will be used
- **Predictive:** must represent some salient characteristics of the modeled artifact well enough to distinguish between *good* and *bad* outcomes of analysis
 - no single model represents all characteristics well enough to be useful for all kinds of analysis
- **Semantically meaningful:** it is usually necessary to interpret analysis results in a way that permits diagnosis of the causes of failure
- **Sufficiently general:** models intended for analysis of some important characteristic must be general enough for practical use in the intended domain of application

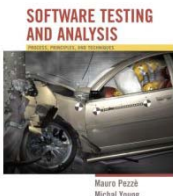

Graph Representations: directed graphs

- Directed graph:
 - N (set of nodes)
 - E (relation on the set of nodes) edges

Nodes: $\{a, b, c\}$

Edges: $\{(a,b), (a, c), (c, a)\}$

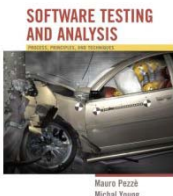
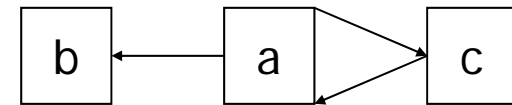
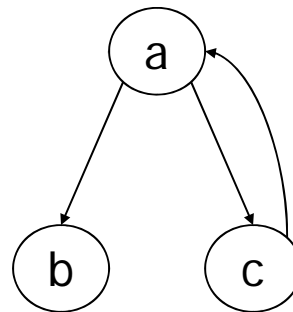

Graph Representations: labels and code

- We can label nodes with the names or descriptions of the entities they represent.
 - If nodes a and b represent program regions containing assignment statements, we might draw the two nodes and an edge (a,b) connecting them in this way:

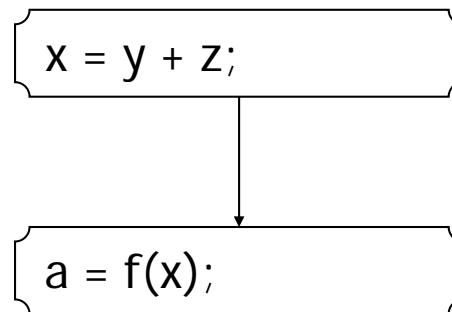

Multidimensional Graph Representations

- Sometimes we draw a single diagram to represent more than one directed graph, drawing the shared nodes only once
 - class B extends (is a subclass of) class A
 - class B has a field that is an object of type C

extends relation

NODES = {A, B, C}

EDGES = {(A,B)}

includes relation

NODES = {A, B, C}

EDGES = {(B,C)}

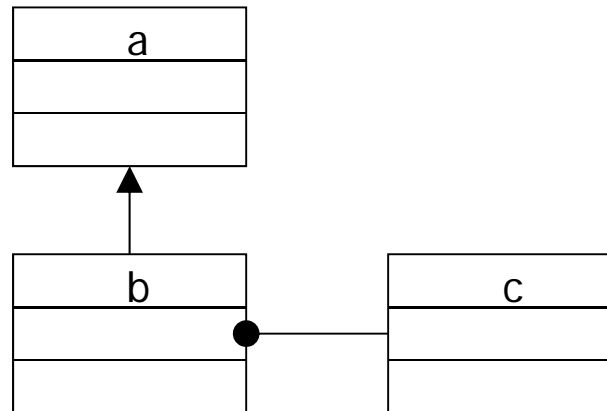

Finite Abstraction of Behavior

an abstraction function suppresses some details of program execution

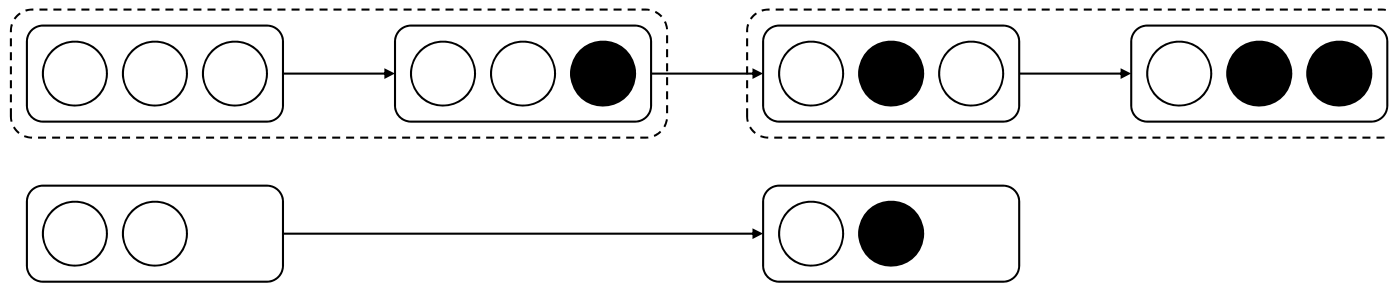

⇒

it lumps together execution states that differ with respect to the suppressed details but are otherwise identical

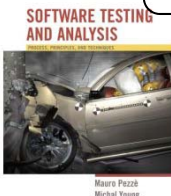
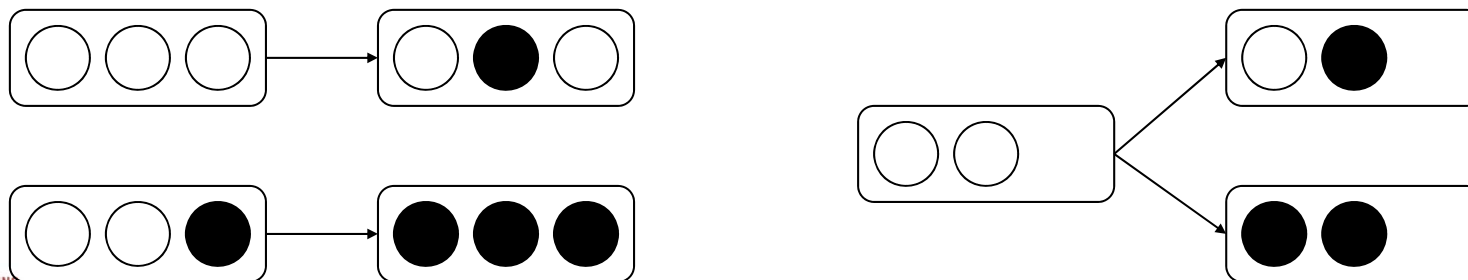

(Intraprocedural) Control Flow Graph

- nodes = regions of source code (basic blocks)
 - Basic block = maximal program region with a single entry and single exit point
 - Often statements are grouped in single regions to get a compact model
 - Sometime single statements are broken into more than one node to model control flow within the statement
- directed edges = possibility that program execution proceeds from the end of one region directly to the beginning of another

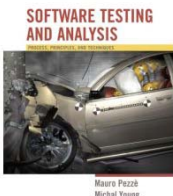

Example of Control Flow Graph

```
public static String collapseNewlines(String argStr)
{
    char last = argStr.charAt(0);
    StringBuffer argBuf = new StringBuffer();

    for (int cldx = 0 ; cldx < argStr.length(); cldx++)
    {
        char ch = argStr.charAt(cldx);
        if (ch != '\n' || last != '\n')
        {
            argBuf.append(ch);
            last = ch;
        }
    }

    return argBuf.toString();
}
```

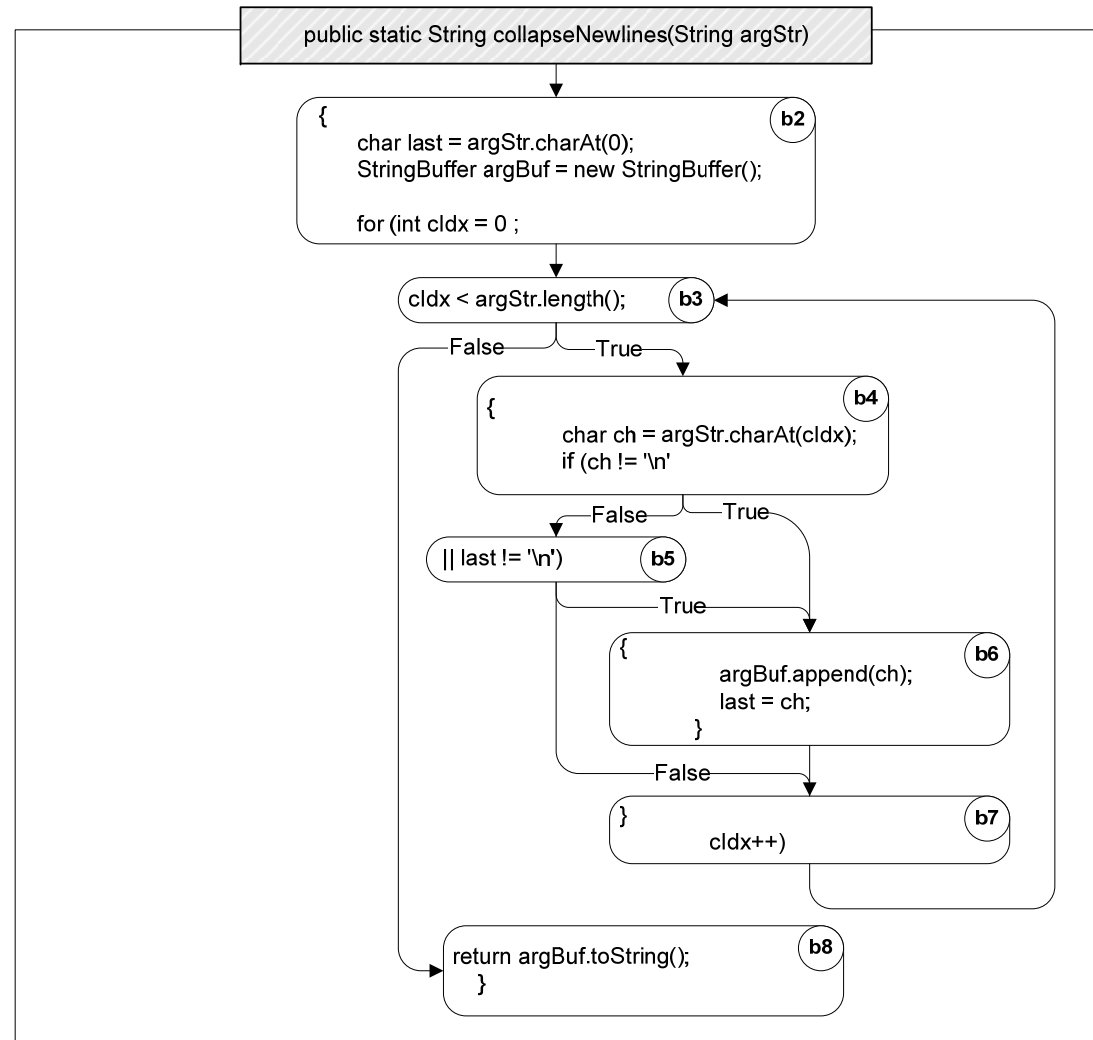

Linear Code Sequence and Jump (LCSJ)

Essentially subpaths of the control flow graph from one branch to another

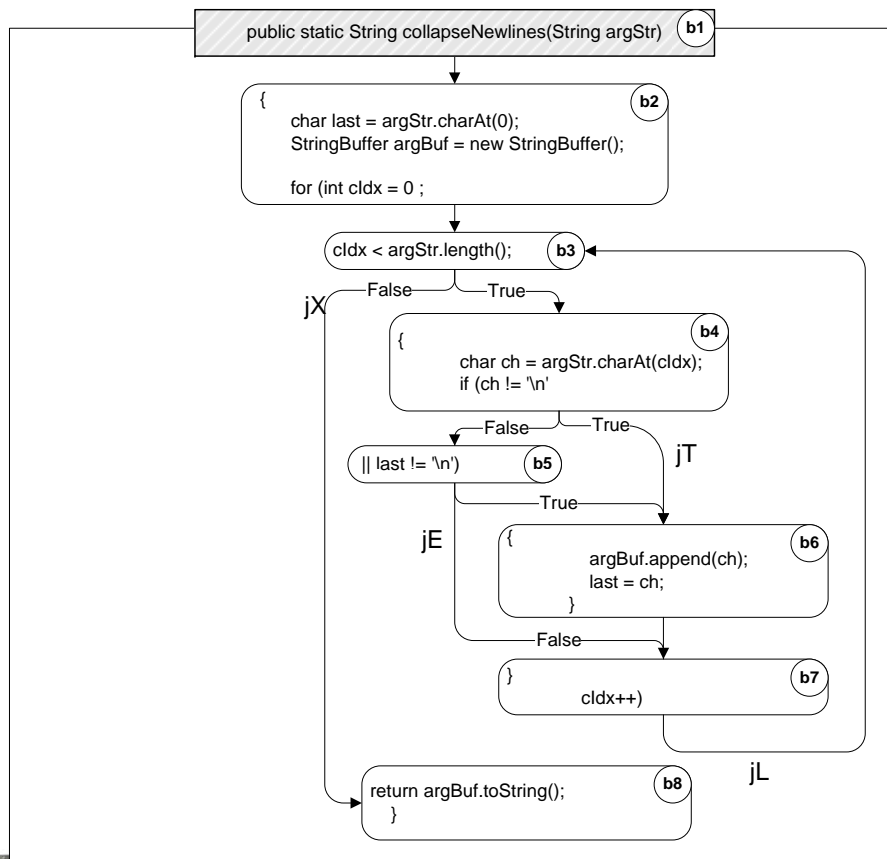

From	Sequence of basic blocs	To
Entry	b1 b2 b3	jX
Entry	b1 b2 b3 b4	jT
Entry	b1 b2 b3 b4 b5	jE
Entry	b1 b2 b3 b4 b5 b6 b7	jL
jX	b8	ret
jL	b3 b4	jT
jL	b3 b4 b5	jE
jL	b3 b4 b5 b6 b7	jL



Interprocedural control flow graph

- Call graphs
 - Nodes represent procedures
 - Methods
 - C functions
 - ...
 - Edges represent *calls* relation

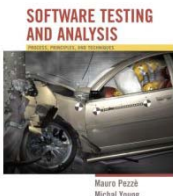

Overestimating the *calls* relation

The static call graph includes calls through dynamic bindings that never occur in execution.

```
public class C {
    public static C cFactory(String kind) {
        if (kind == "C") return new C();
        if (kind == "S") return new S();
        return null;
    }
    void foo() {
        System.out.println("You called the parent's method");
    }
    public static void main(String args[]) {
        (new A()).check();
    }
}
class S extends C {
    void foo() {
        System.out.println("You called the child's method");
    }
}
class A {
    void check() {
        C myC = C.cFactory("S");
        myC.foo();
    }
}
```

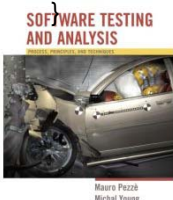
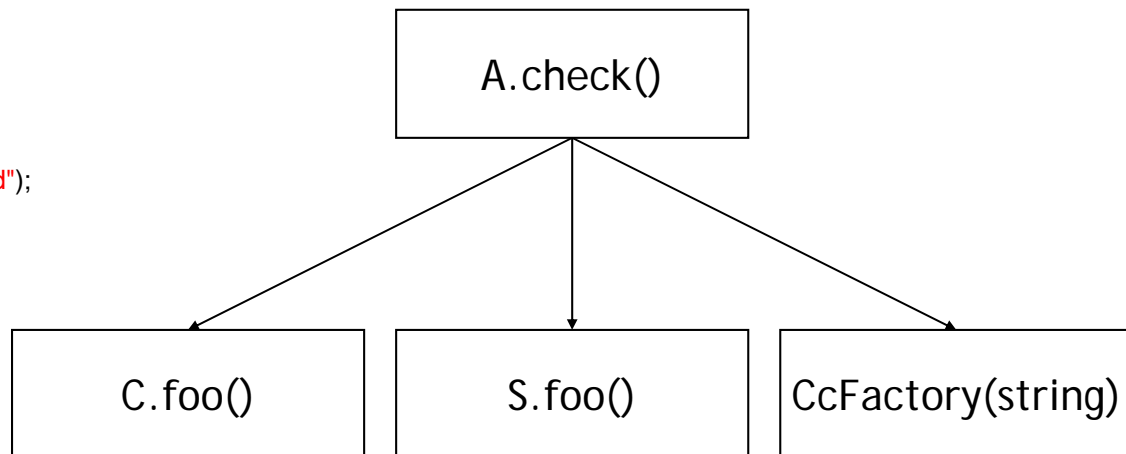

Context Insensitive Call graphs

```
public class Context {  
    public static void main(String args[]) {  
        Context c = new Context();  
        c.foo(3);  
        c.bar(17);  
    }  
  
    void foo(int n) {  
        int[] myArray = new int[ n ];  
        depends( myArray, 2 );  
    }  
  
    void bar(int n) {  
        int[] myArray = new int[ n ];  
        depends( myArray, 16 );  
    }  
  
    void depends( int[] a, int n ) {  
        a[n] = 42;  
    }  
}
```

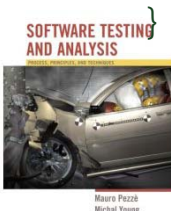
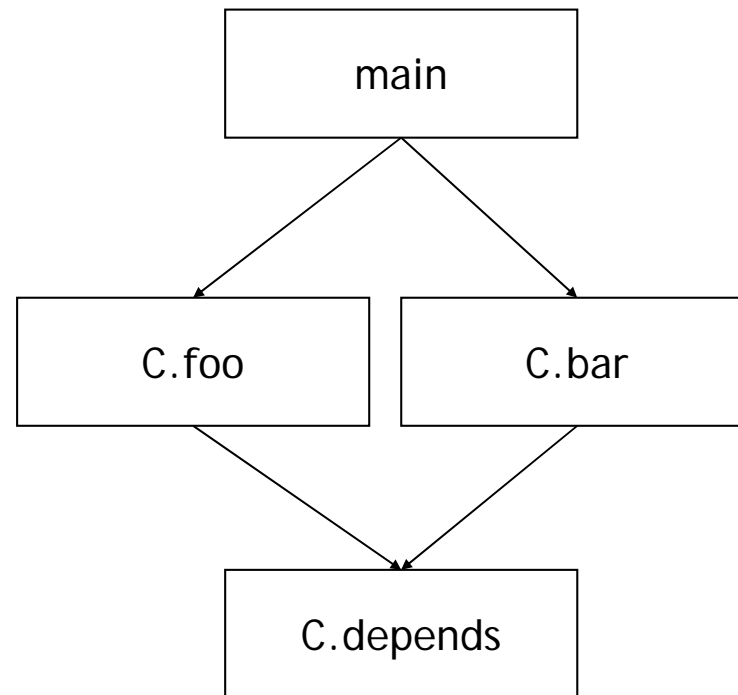

Context Sensitive Call graphs

```
public class Context {  
    public static void main(String args[]) {  
        Context c = new Context();  
        c.foo(3);  
        c.bar(17);  
    }  
  
    void foo(int n) {  
        int[] myArray = new int[ n ];  
        depends( myArray, 2 );  
    }  
  
    void bar(int n) {  
        int[] myArray = new int[ n ];  
        depends( myArray, 16 );  
    }  
  
    void depends( int[] a, int n ) {  
        a[n] = 42;  
    }  
}
```

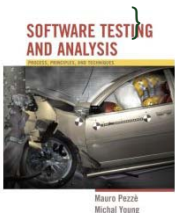
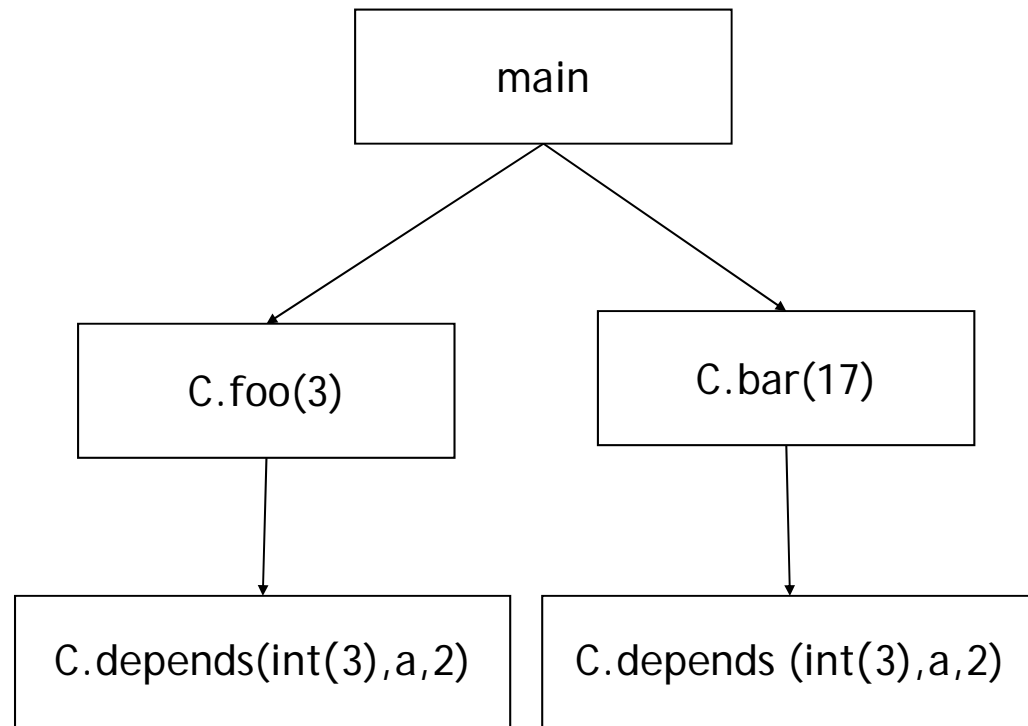

Context Sensitive CFG exponential growth

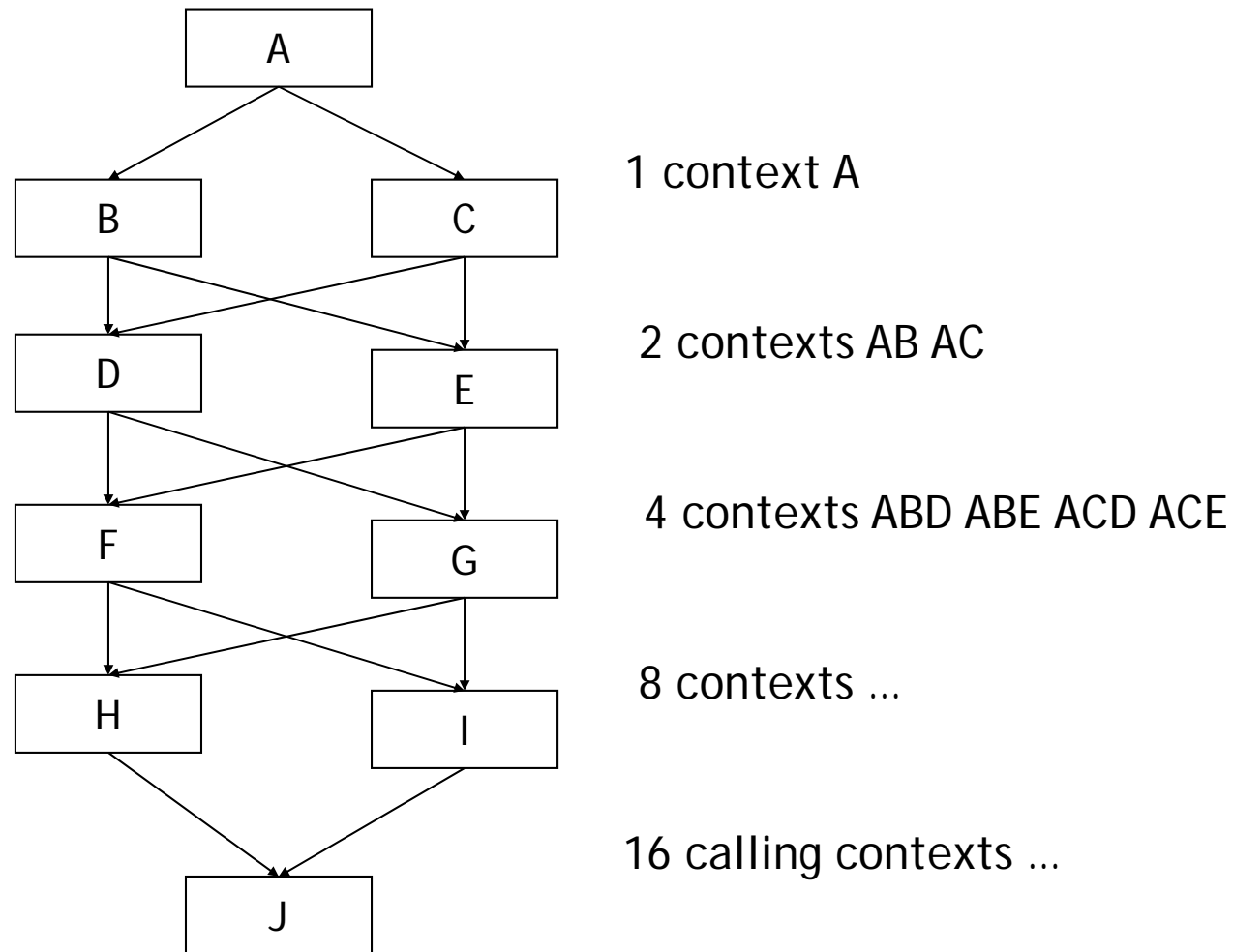

Finite state machines

- finite set of states (nodes)
- set of transitions among states (edges)

Graph representation (Mealy machine)

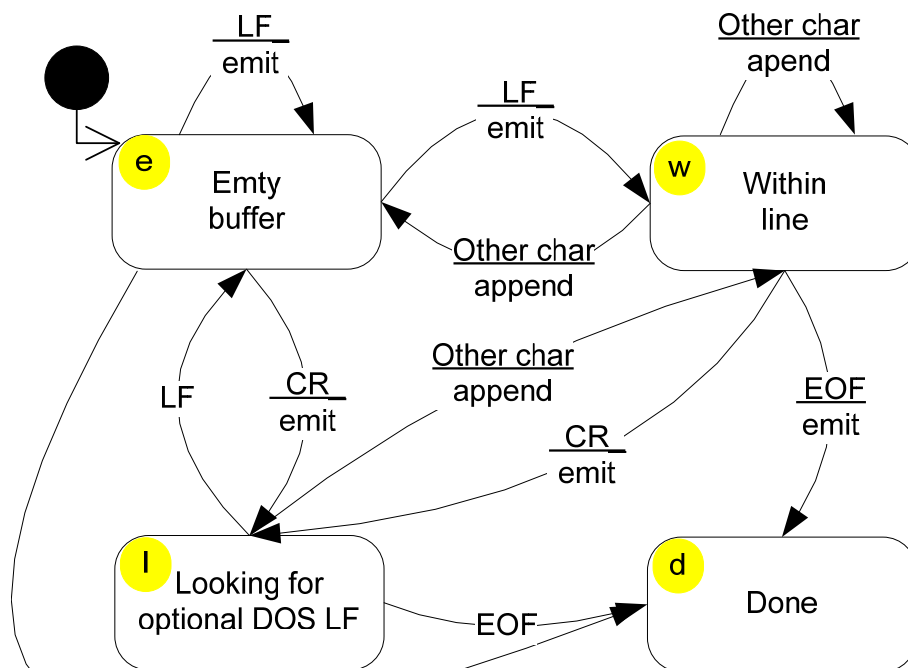

Tabular representation

	LF	CR	EOF	other
e	e/emit	e/emit	d/-	w/append
w	e/emit	e/emit	d/emit	w/append
l	e/-		d/-	w/append

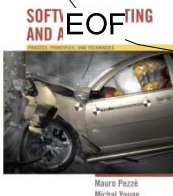

Using Models to Reason about System Properties

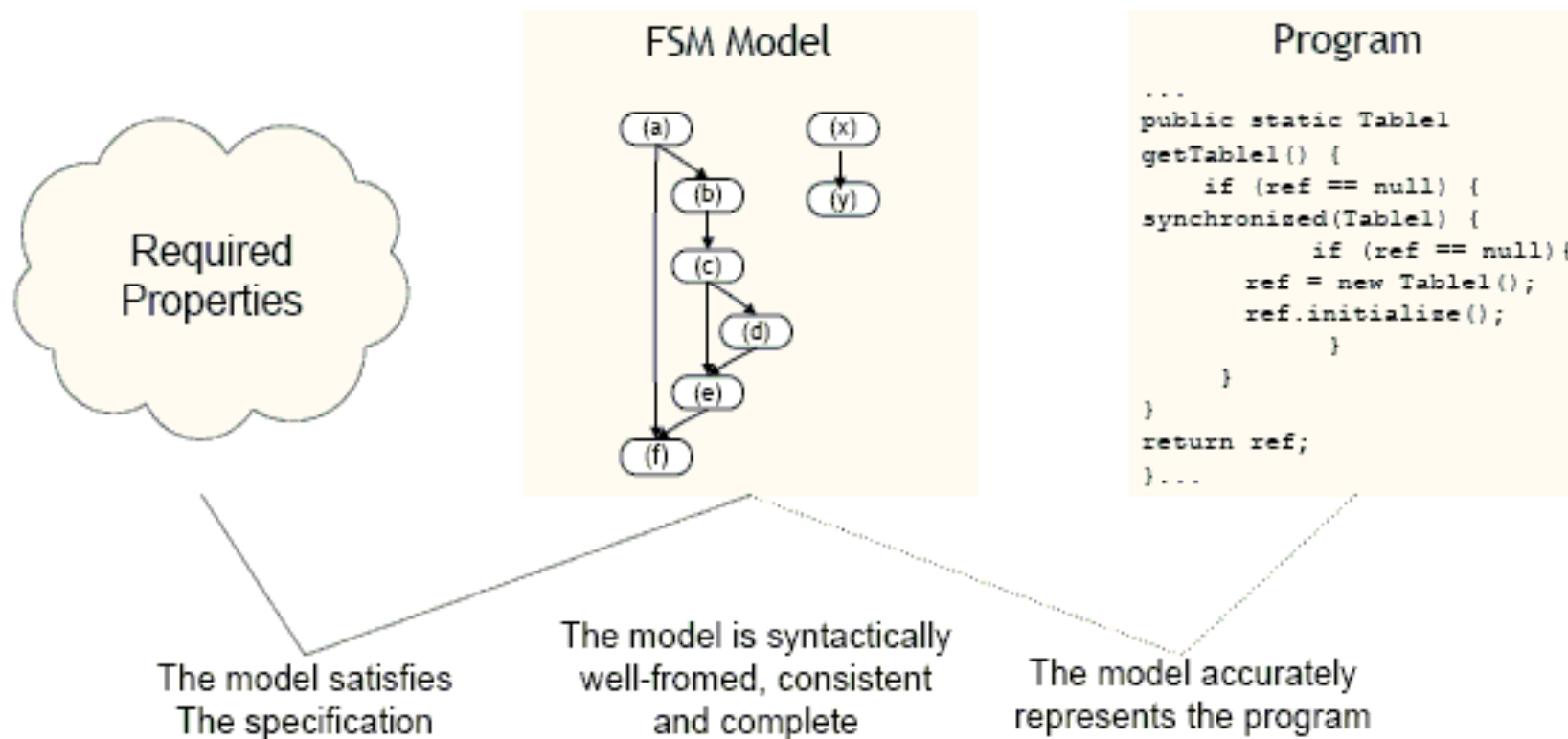

Abstraction Function

```

1  /** Convert each line from standard input */
2  void transduce() {
3
4  #define BUFLLEN 1000
5  char buf[BUFLLEN]; /* Accumulate line into this buffer */
6  int  pos = 0;      /* Index for next character in buffer */
7
8  char inChar; /* Next character from input */
9
10 int atCR = 0; /* 0="within line", 1="optional DOS LF" */
11
12 while ((inChar = getchar()) != EOF) {
13     switch (inChar) {
14     case LF:
15         if (atCR) { /* Optional DOS LF */
16             atCR = 0;
17         } else { /* Encountered CR within line */
18             emit(buf, pos);
19             pos = 0;
20         }
21         break;
22     case CR:
23         emit(buf, pos);
24         pos = 0;
25         atCR = 1;
26         break;
27     default:
28         if (pos >= BUFLLEN-2) fail("Buffer overflow");
29         buf[pos++] = inChar;
30     } /* switch */
31 }
32 if (pos > 0) {
33     emit(buf, pos);
34 }
35 }

```

Abstract state	Concrete state		
	Lines	atCR	pos
e (Empty buffer)	3 – 13	0	0
w (Within line)	13	0	> 0
l (Looking for LF)	13	1	0
d (Done)	36	–	–



	LF	CR	EOF	other
e	e / emit	l / emit	d / –	w / append
w	e / emit	l / emit	d / emit	w / append
l	e / –	l / emit	d / –	w / append



Summary

- Models must be much simpler than the artifact they describe to be understandable and analyzable
- Must also be sufficiently detailed to be useful
- CFG are built from software
- FSM can be built before software to document intended behavior

