

Early Vision and Visual System Development

Dr. James A. Bednar

jbednar@inf.ed.ac.uk

<http://homepages.inf.ed.ac.uk/jbednar>

Studying the visual system (1)

The visual system can be (and is) studied using many different techniques. In this course we will consider:

Psychophysics What is the level of human visual performance under various different conditions?

Anatomy Where are the visual system parts located, and what do they look like?

Gross anatomy What do the visual system organs and tissues look like, and how are they connected?

Histology What cellular and subcellular structures can be seen under a microscope?

Studying the visual system (2)

Physiology What is the behavior of the component parts of the visual system?

Electrophysiology What is the electrical behavior of neurons, measured with an electrode?

Imaging What is the behavior of a large area of the nervous system?

Genetics Which genes control visual system development and function, and what do they do?

Electromagnetic spectrum

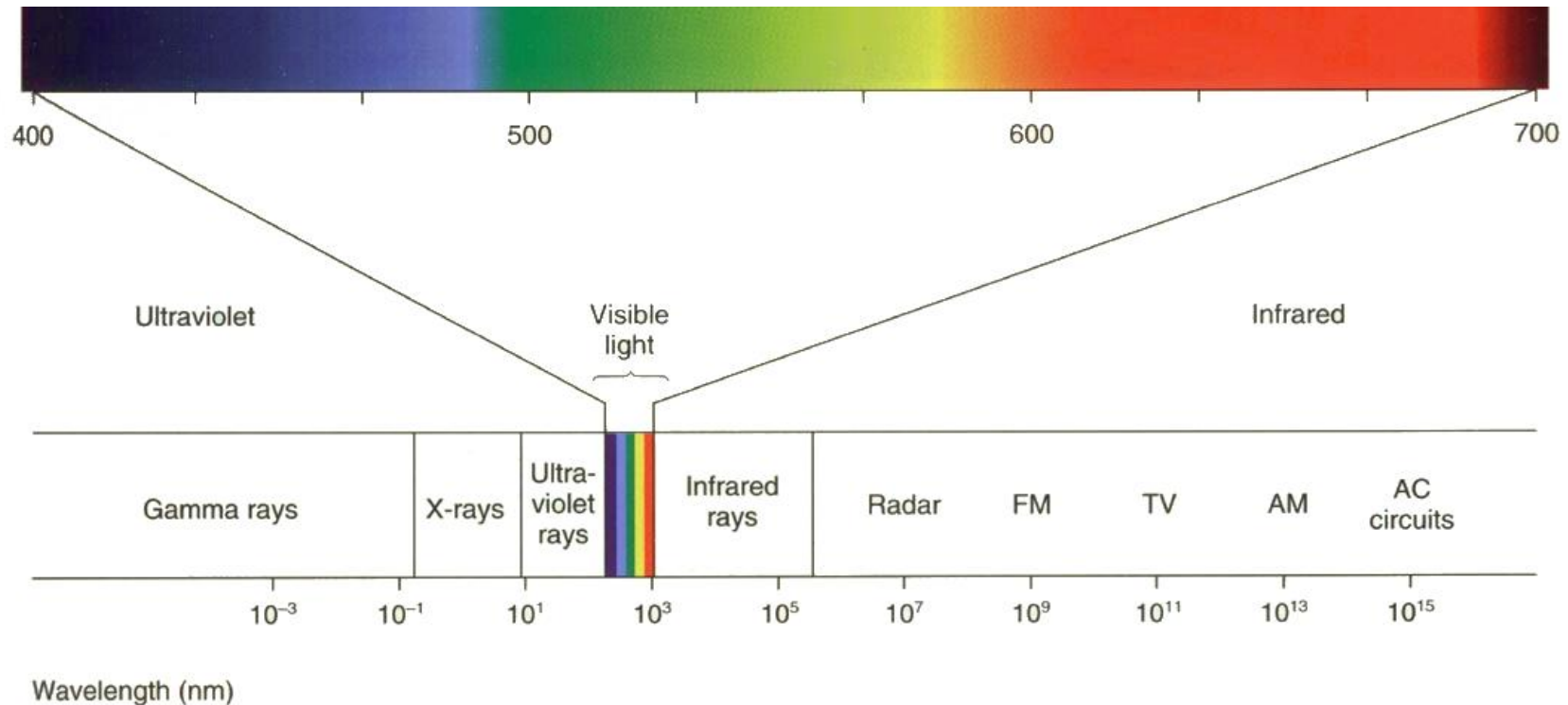

(From web)

Start with the physics: visible portion is small, but provides much information about biologically relevant stimuli

Cone spectral sensitivities

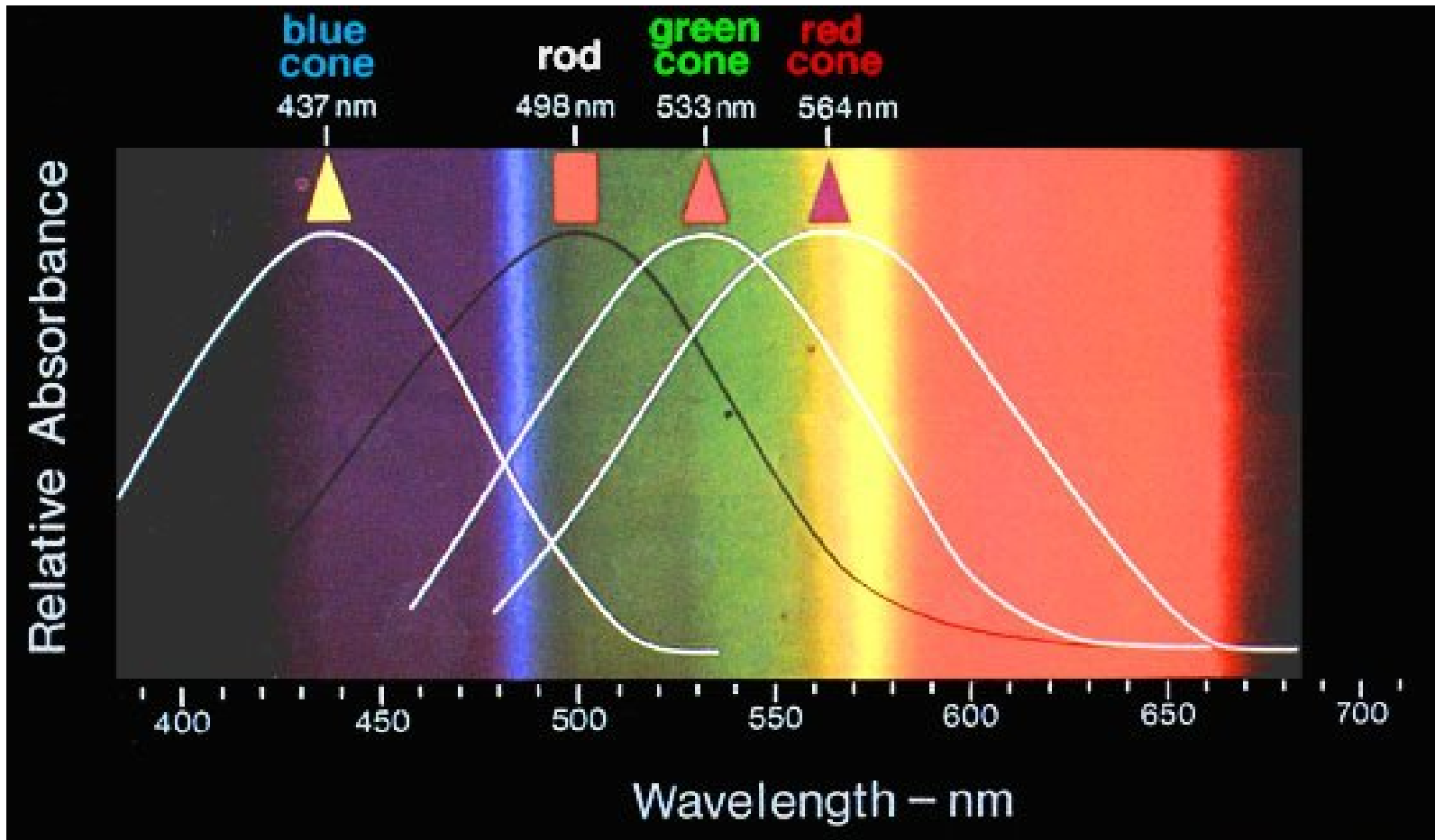

(Dowling, 1987)

Somehow we make do with sampling the visible range of wavelengths at only three points (3 cone types)

Early visual pathways

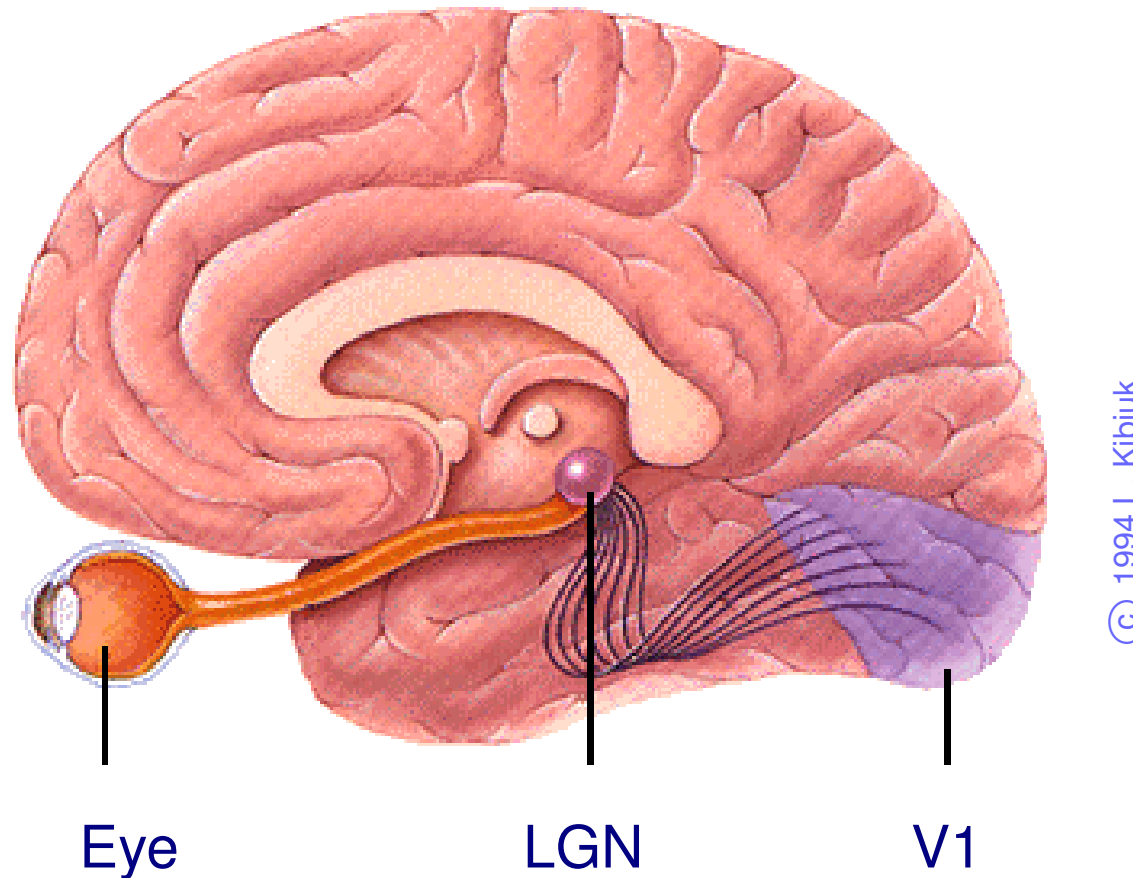

Signals travel from retina, to LGN,
then to primary visual cortex

Circuit diagram

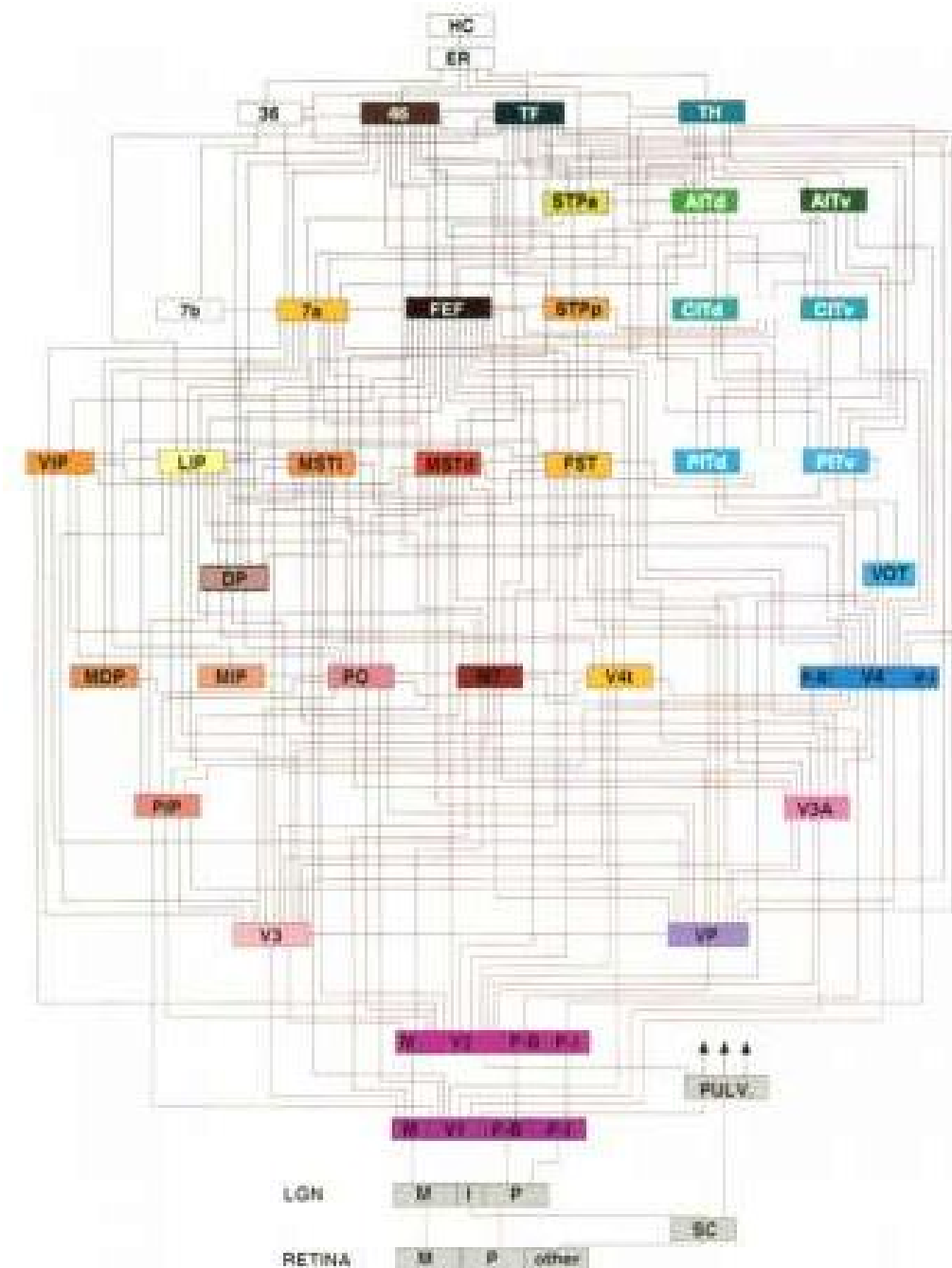

Connections
between
macaque
monkey visual
areas

(Van Essen et al. 1992)

A bit messy!

(Yet still just a start.)

Image formation

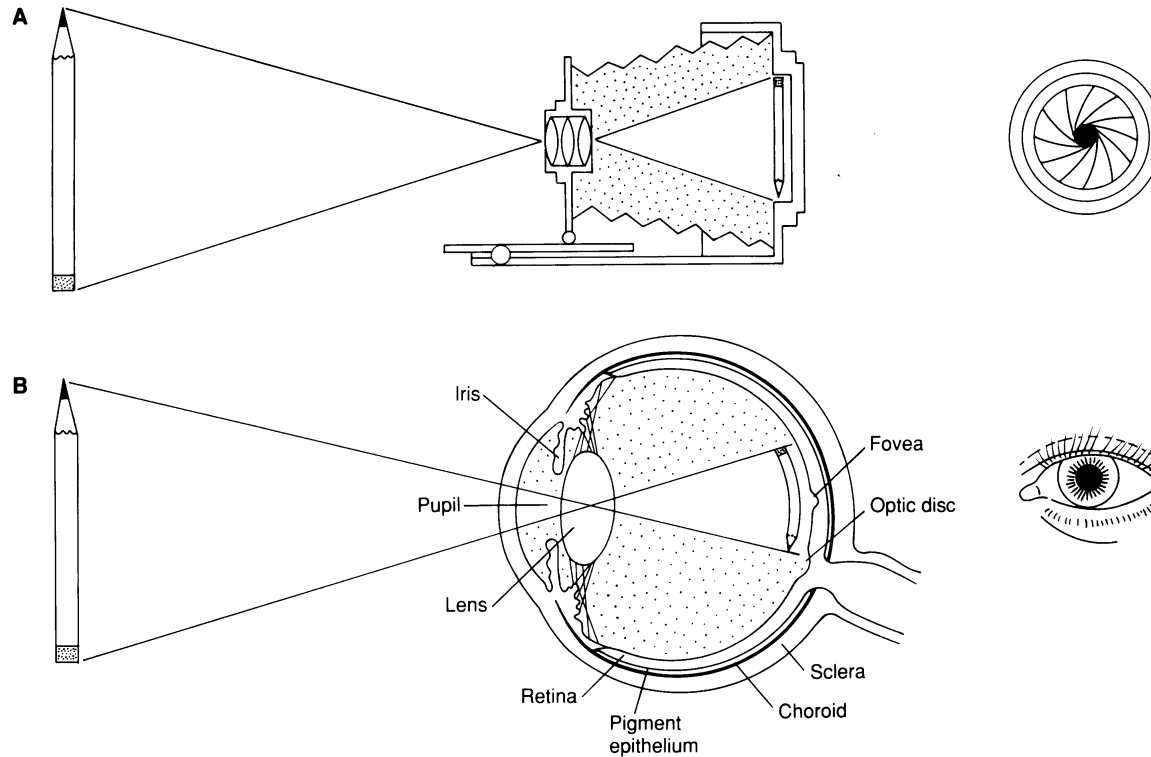

(Kandel et al. 1991)

	Fixed	Adjustable	Sampling
Camera:	lens shape	focal length	uniform
Eye:	focal length	lens shape	higher at fovea

Visual fields

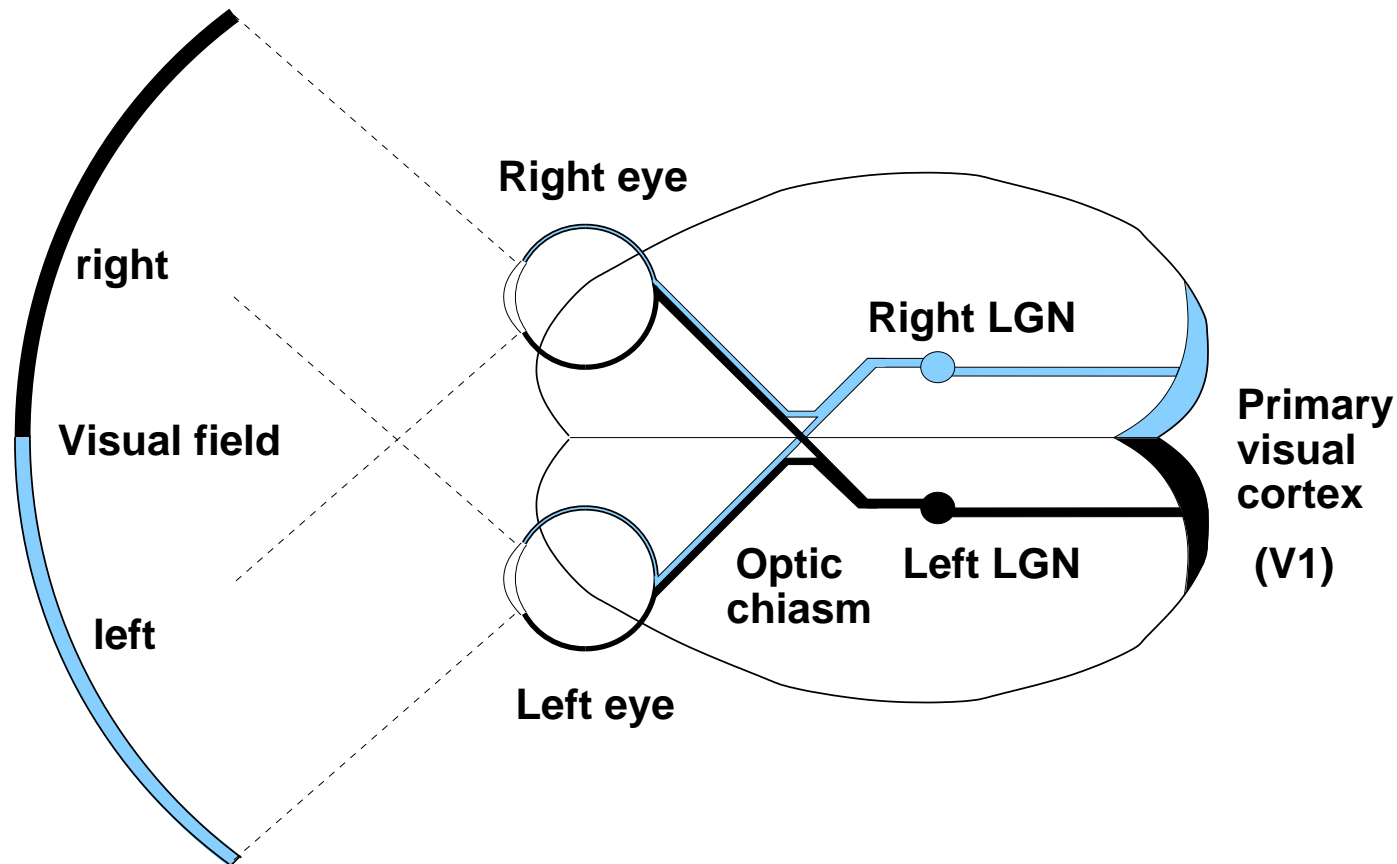

CMVC figure 2.1

- Each eye sees partially overlapping areas
- Inputs from opposite hemifield cross over at chiasm

Retinotopic map

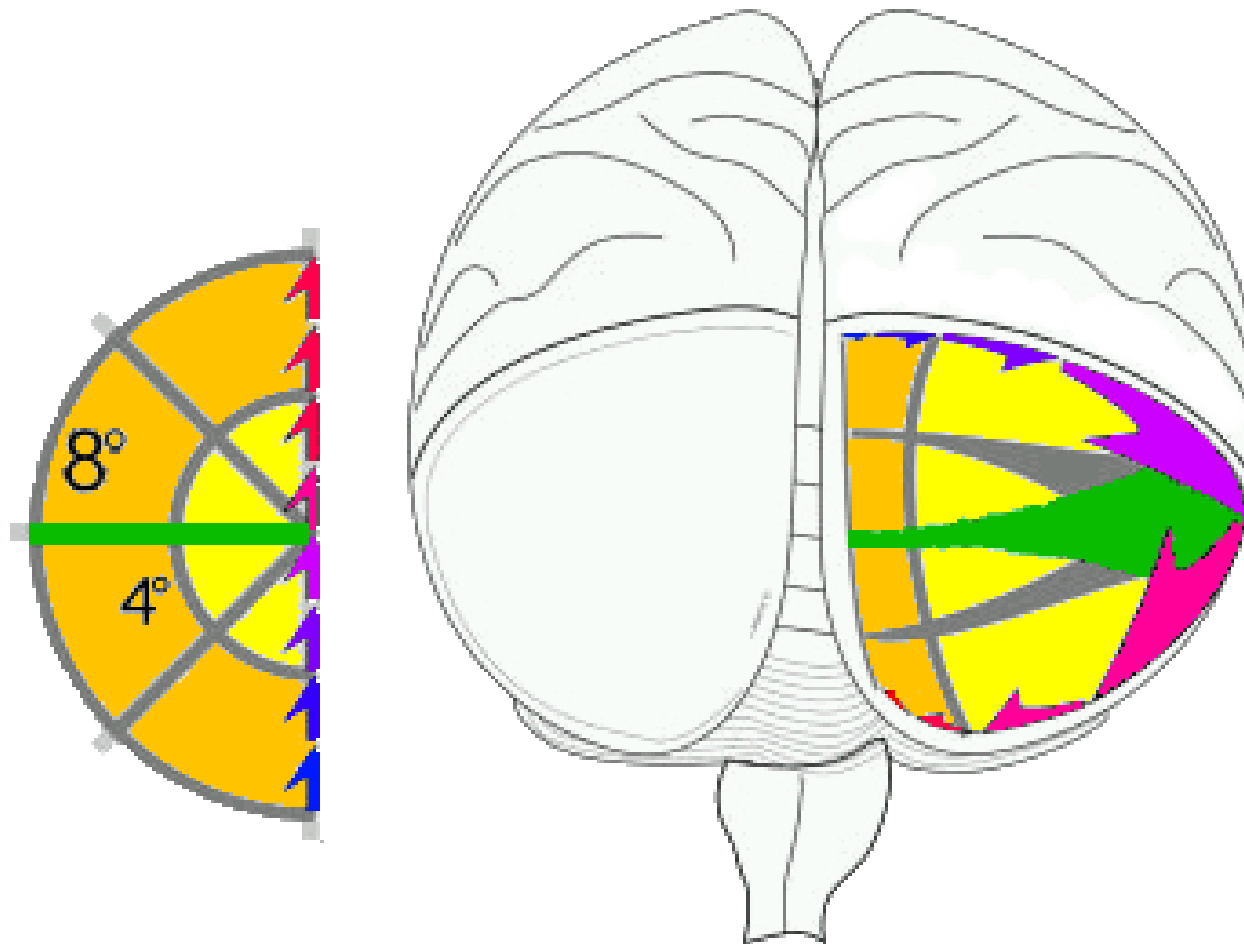

Mapping of
visual field in
macaque
monkey

Blasdel and
Campbell
2001

- Visual field is mapped onto cortical surface
- Fovea is overrepresented

Effect of foveation



(From omni.isr.ist.utl.pt)

Smaller, tightly packed cones in the fovea
give much higher resolution

Retinal surface

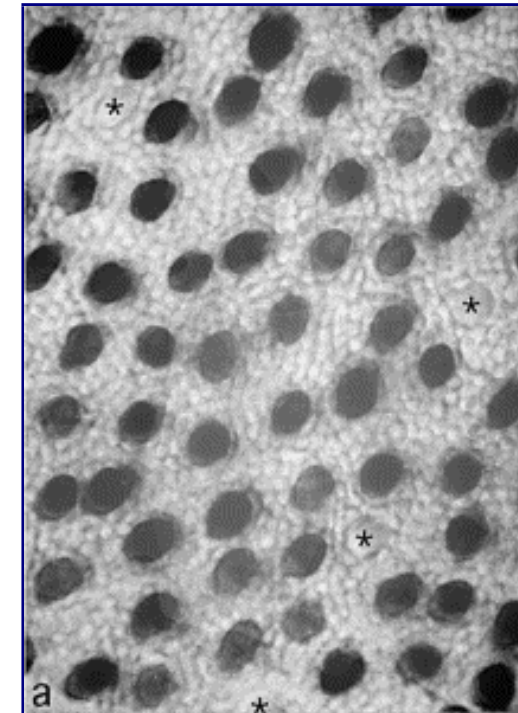
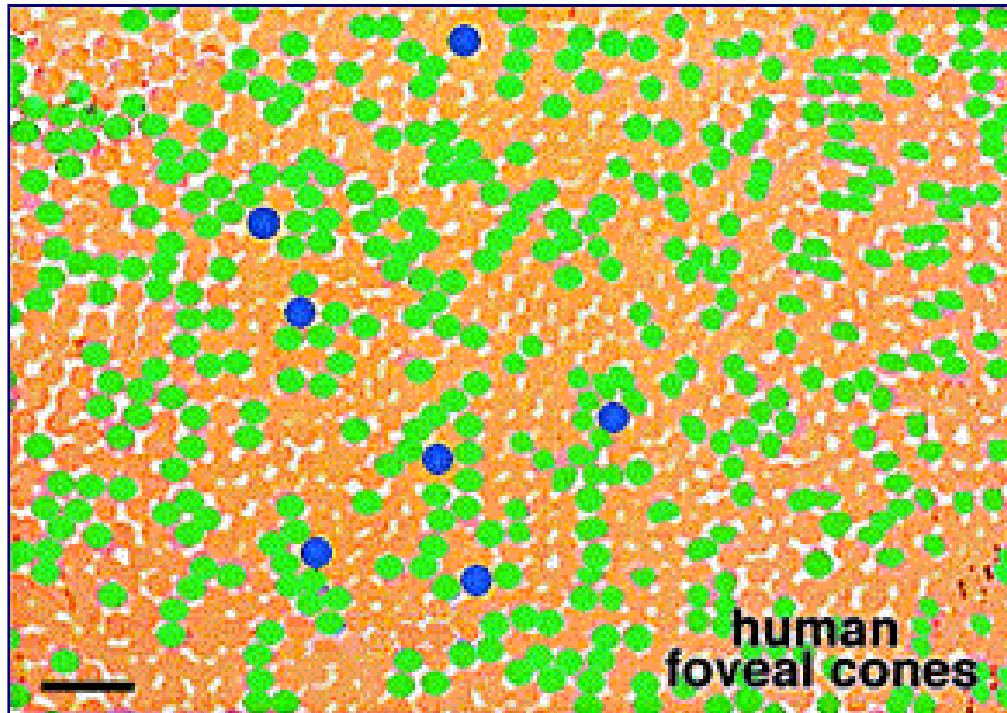

(Ahneilt & Kolb 2000); no scale in original

Fovea (center \rightsquigarrow)

Periphery

- Fovea: densely packed L,M cones (no rods)
- No S cones in central fovea; sparse elsewhere
- Cones are larger in periphery (*: S-cones)
- Cone spacing also increases, with gaps filled by rods

Retinal circuits

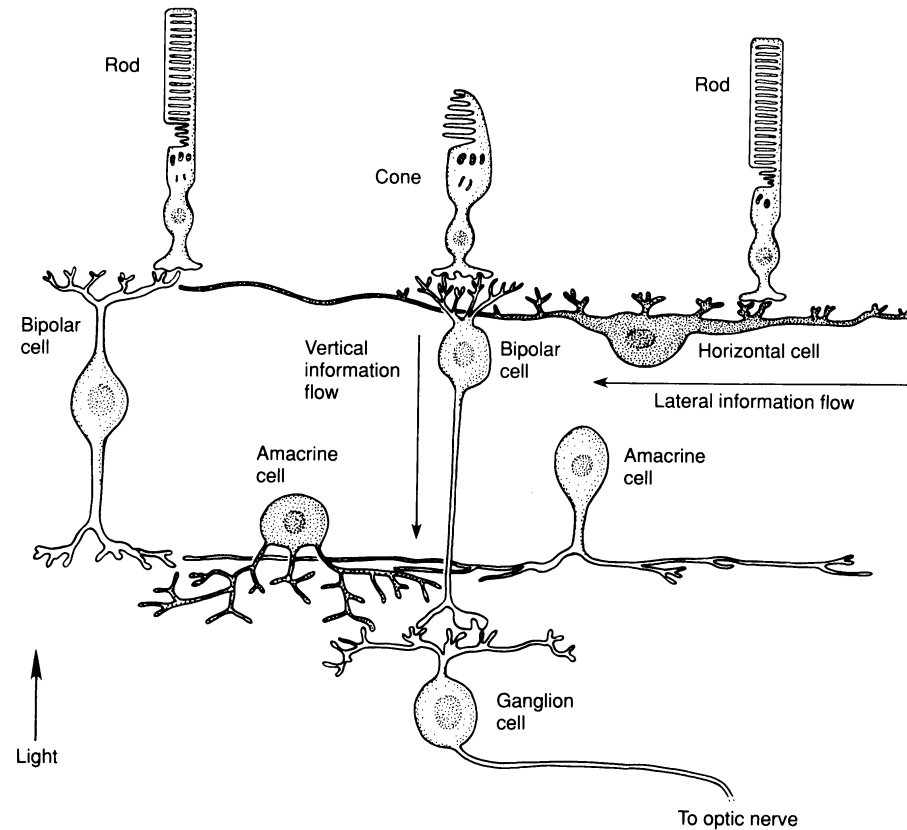

(Kandel et al. 1991)

Rod pathway Rod, rod bipolar cell, ganglion cell

Cone pathway Cone, bipolar cell, ganglion cell

LGN layers

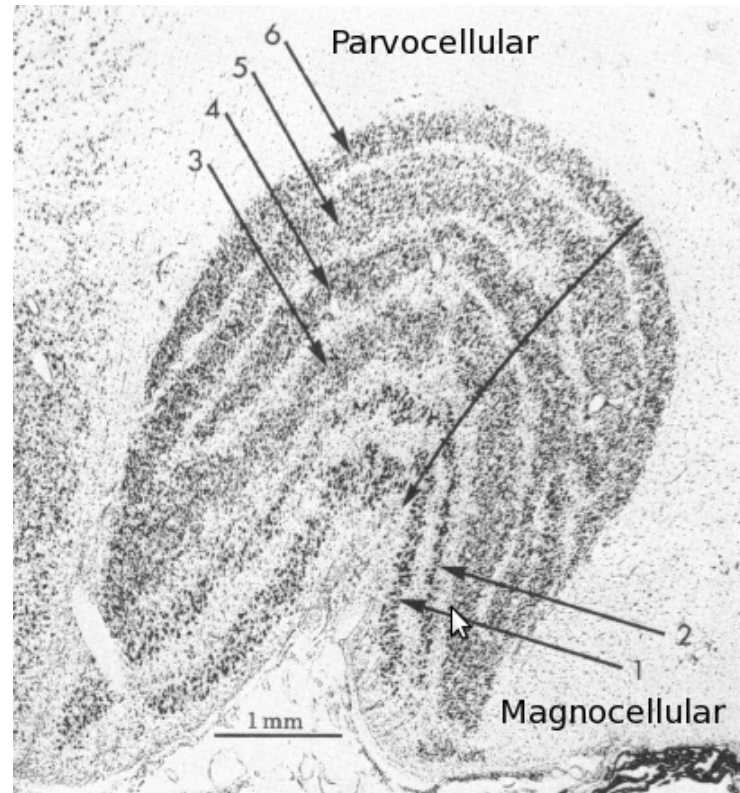

Macaque; Hubel & Wiesel 1977

Multiple aligned representations of visual field in the LGN
for different eyes and cell types

V1 layers

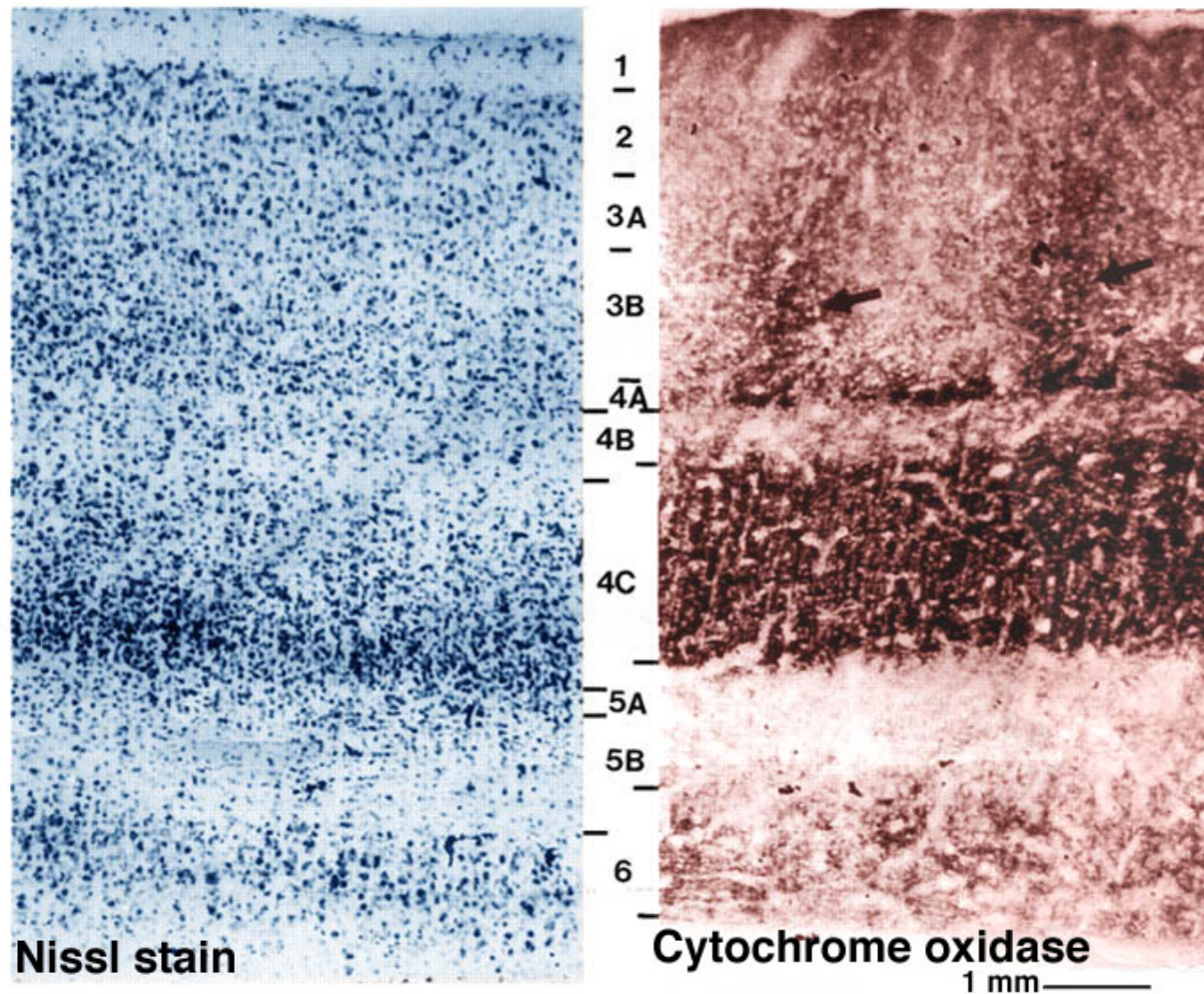

(From webvision.umh.es)

Multiple layers of cells in V1

Brodmann numbering

Retinal/LGN cell response types

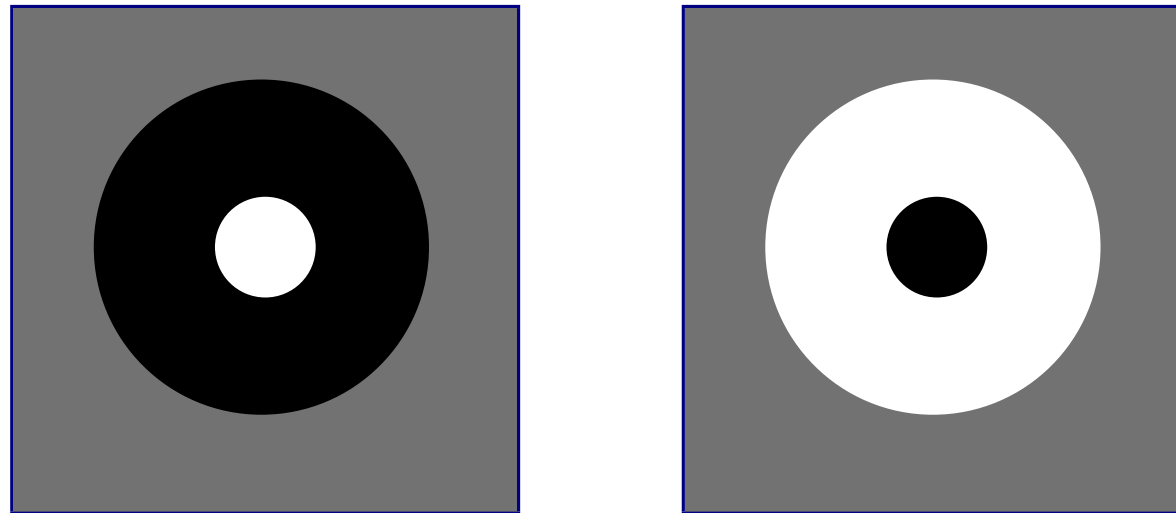

Types of receptive fields based on responses to light:

	in center	in surround
On-center	excited	inhibited
Off-center	inhibited	excited

Color-opponent retinal/LGN cells

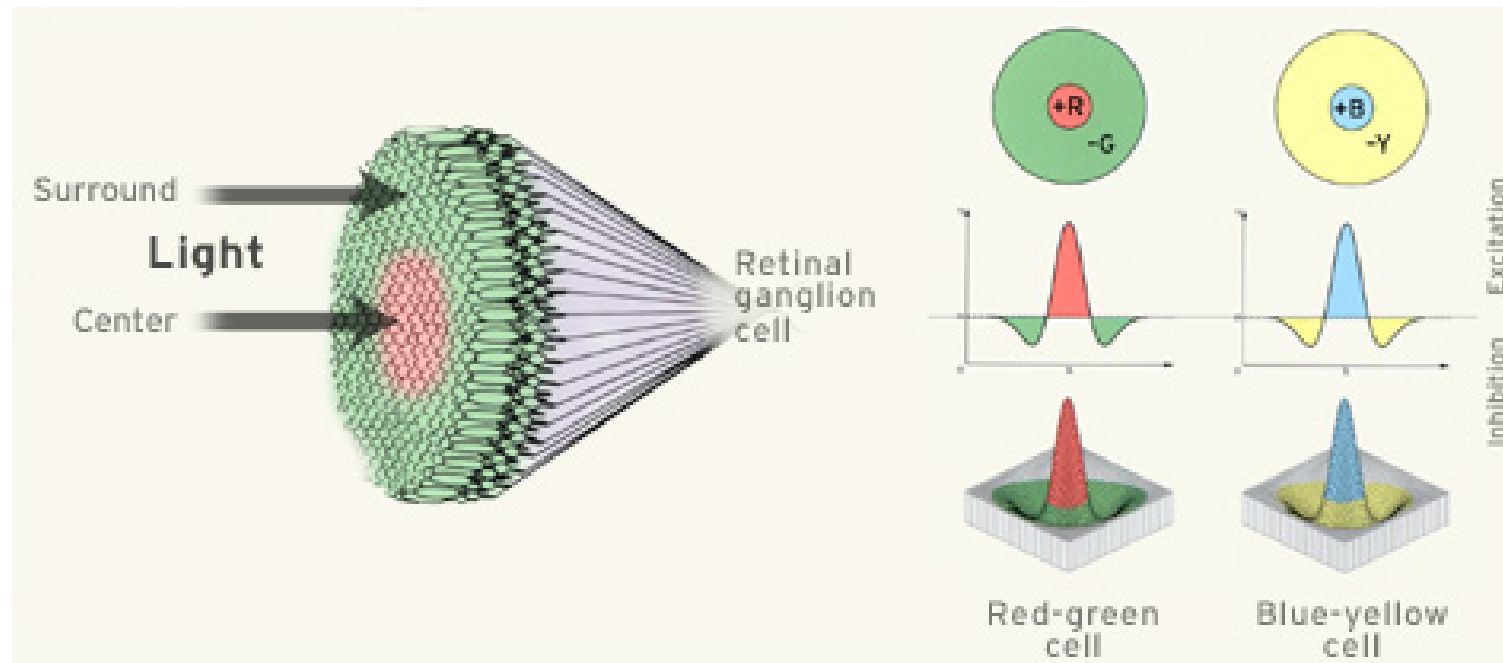

(From webexhibits.org)

Red/Green cells: (+R,-G), (-R,+G), (+G,-R), (-G,+R)

Blue/Yellow cells: (+B,-Y); others?

Error: light arrows in the figure are backwards! Actual organization mostly consistent with random wiring

V1 simple cell responses

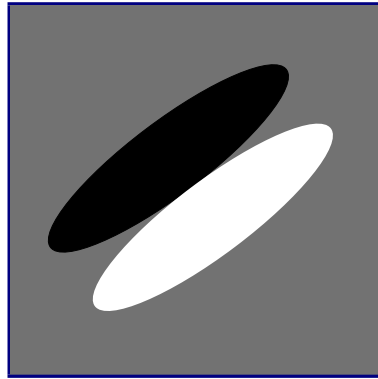

2-lobe simple
cell

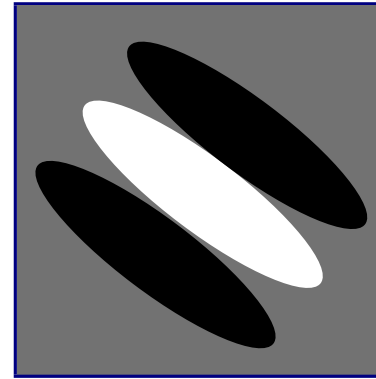

3-lobe simple
cell

Starting in V1, only oriented patterns will cause any significant response

Simple cells: pattern preferences can be plotted as above

V1 complex cell responses

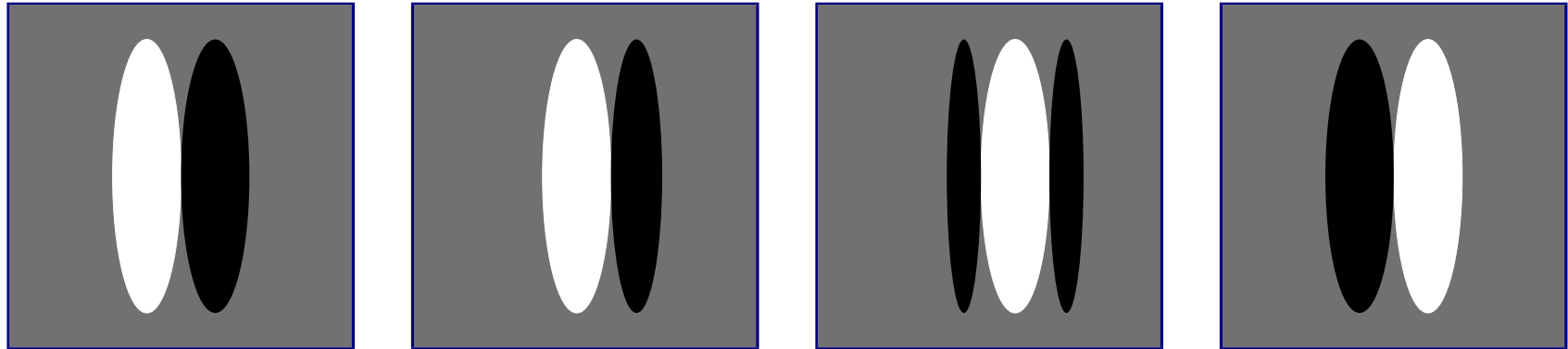

(Same response to all these patterns)

Complex cells are also orientation selective, but have responses invariant to phase

Can't measure complex RFs using pixel-based correlations

Spatiotemporal receptive fields

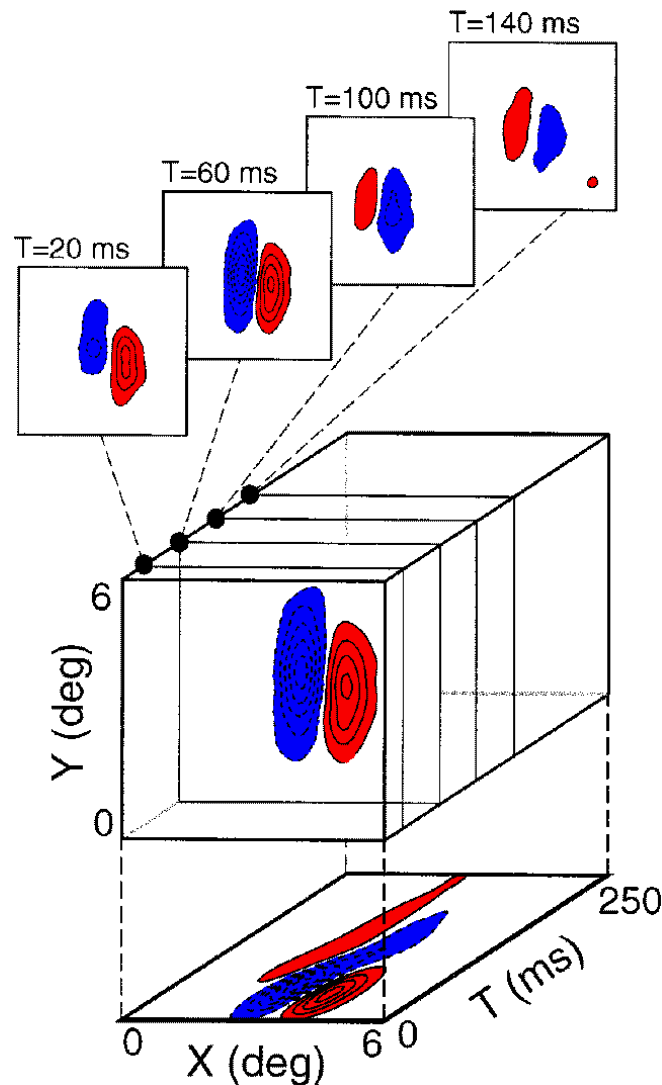

- Neurons are selective for multiple stimulus dimensions at once
- Typically prefer lines moving in direction perpendicular to orientation preference

(Cat V1; DeAngelis et al. 1999)

Contrast perception

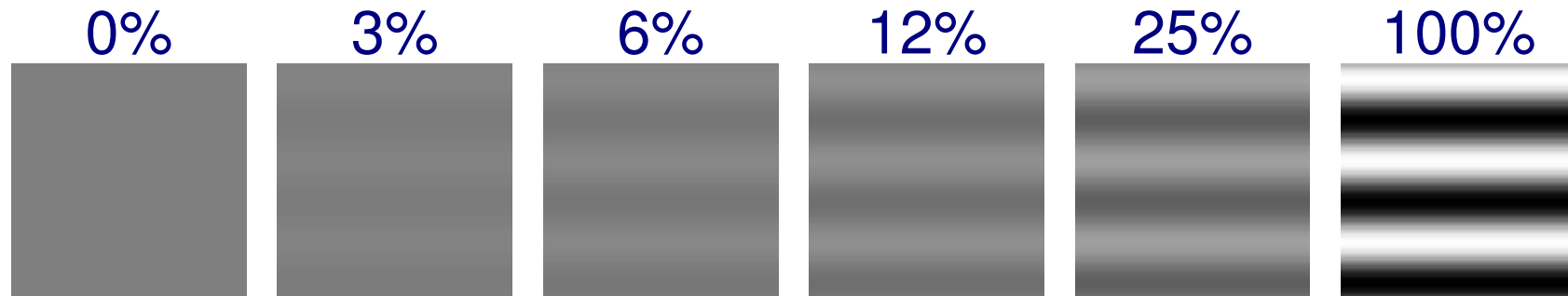

- Humans can detect patterns over a huge contrast range
- In the laboratory, increasing contrast above a fairly low value does not aid detection
- See 2AFC (two-alternative forced-choice) test in google and ROC (Receiver Operating Characteristic) in Wikipedia for more info on how such tests work

Contrast-invariant tuning

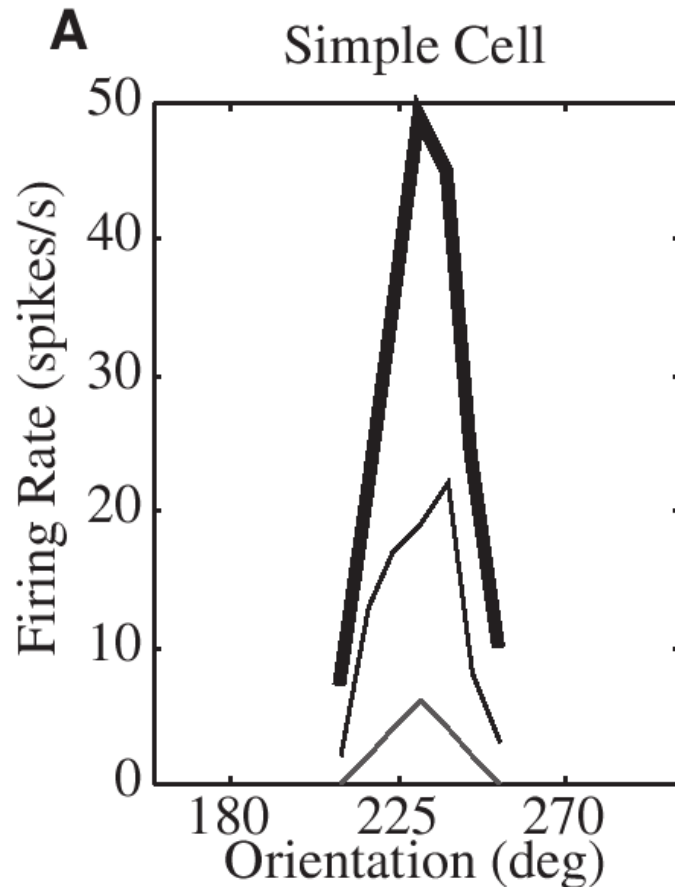

(Sclar & Freeman 1982)

- Single-cell tuning curves are typically Gaussian
- 5%, 20%, 80% contrasts shown
- Peak response increases, but
- Tuning width changes little
- Contrast where peak is reached varies by cell

Definitions of contrast

Luminance (luminosity): Physical amount of light

Contrast: Luminance relative to background levels to which the visual system has become adapted

Contrast is a fuzzy concept – clear only in special cases:

Weber contrast (e.g. a tiny spot on uniform background)

$$C = \frac{L_{max} - L_{min}}{L_{min}}$$

Michelson contrast (e.g. a full-field sine grating):

$$C = \frac{L_{max} - L_{min}}{L_{max} + L_{min}} = \frac{L_{max} - L_{min}}{2 L_{avg}}$$

Measuring cortical maps

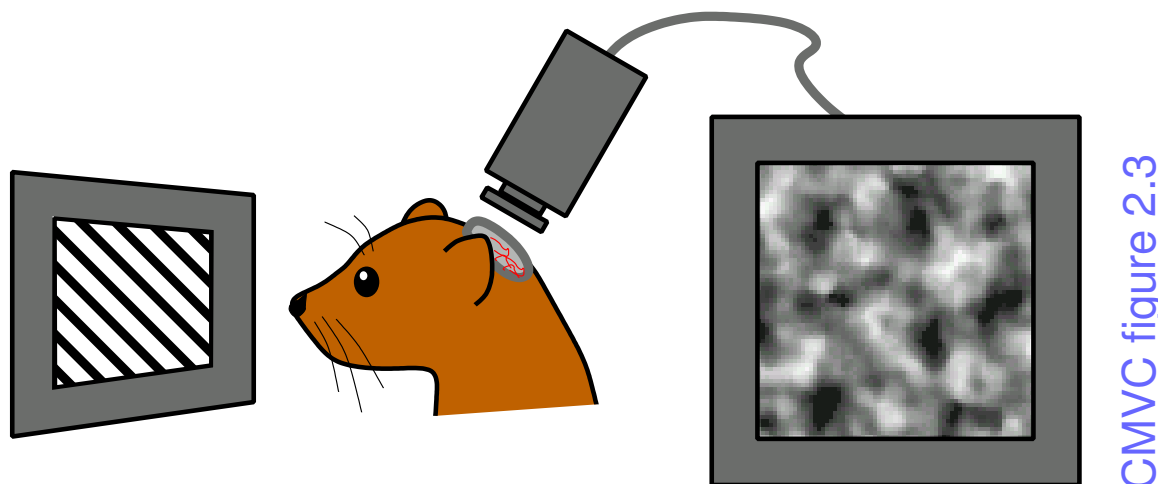

CMVC figure 2.3

- Surface reflectance (or voltage-sensitive-dye emission) changes with activity
- Measured with optical imaging
- Preferences computed as correlation between measurement and input

Retinotopy/orientation map

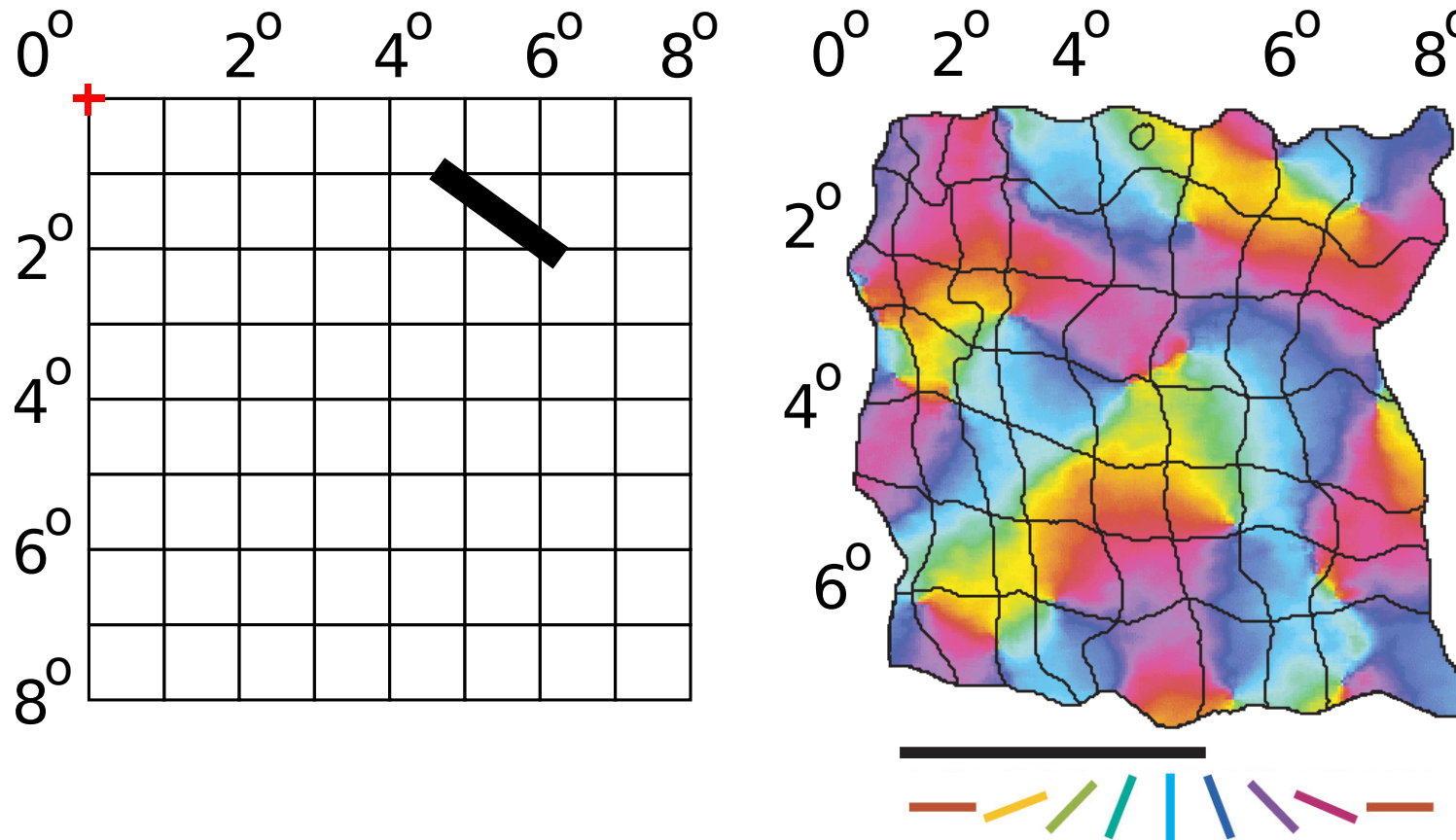

Tree shrew; Bosking et al. 2002; 2 × 2mm

- Tree shrew has no fovea \rightsquigarrow isotropic map
- All orientations represented for each retina location
- Orientation map is smooth, with local patches

Macaque orientation map

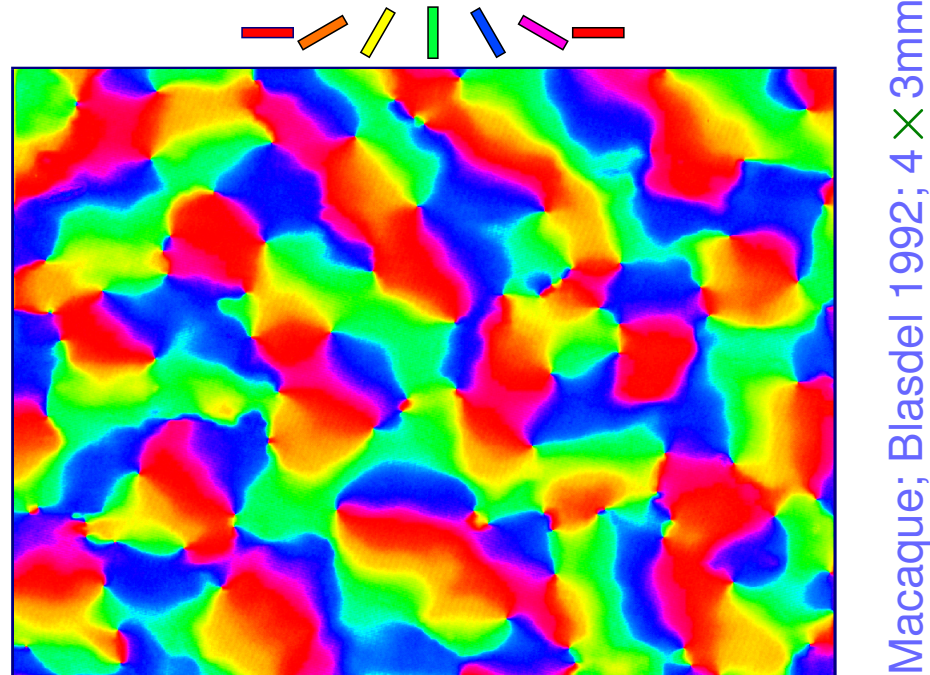

- Macaque monkey has fovea but similar orientation map
- Retinotopic map (not measured) highly nonlinear

Ocular dominance map in V1

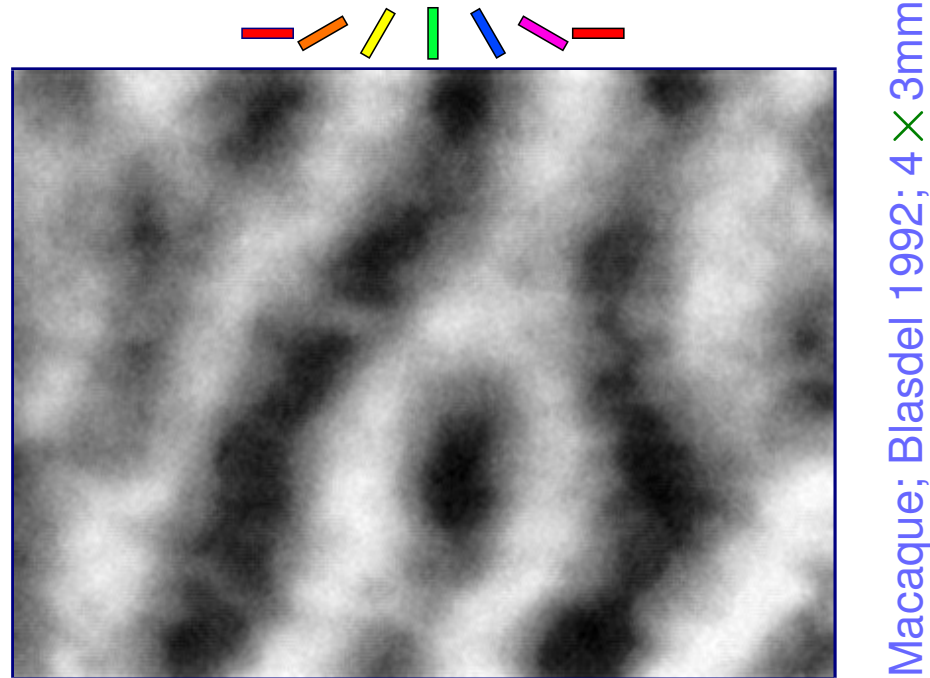

- Most neurons are binocular, but prefer one eye
- Eye preference alternates in stripes or patches

Combined OR/OD map in V1

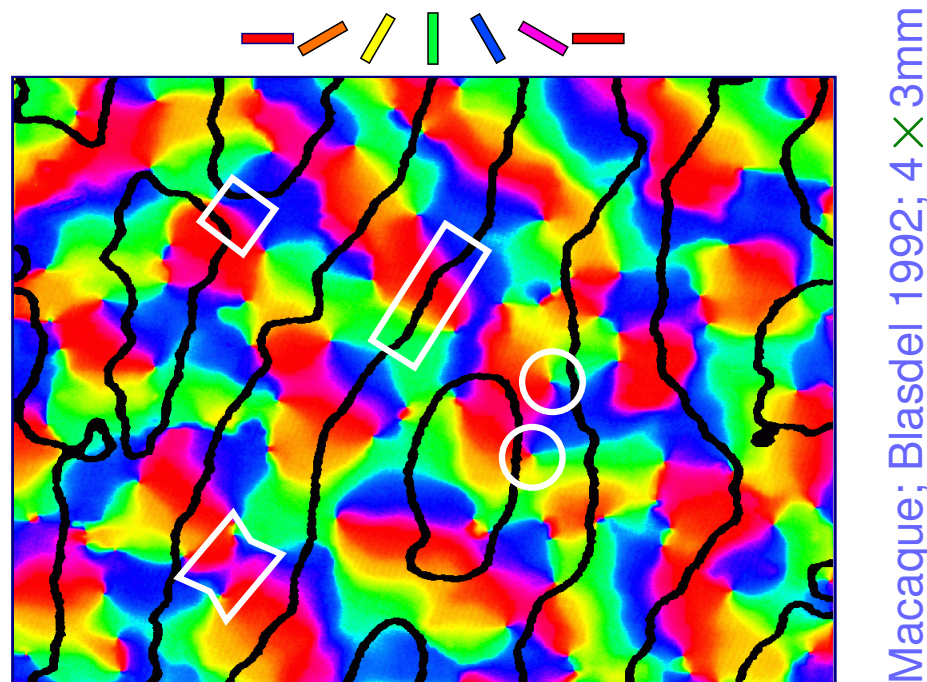

- Same neurons have preference for both features
- OR has linear zones, fractures, pinwheels, saddles
- OD boundaries typically align with linear zones

Direction map in V1

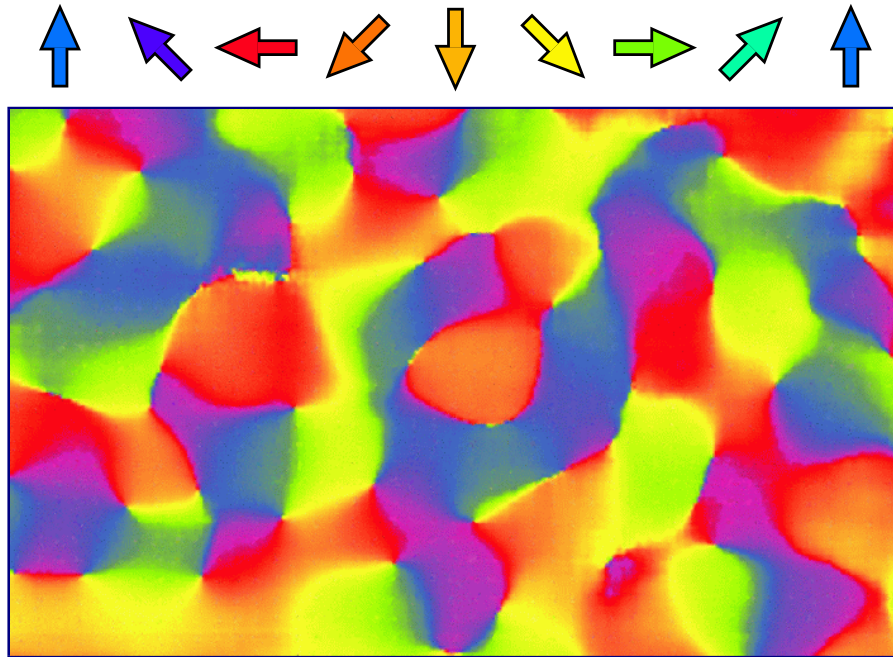

Direction preference

(3.2 × 2mm)

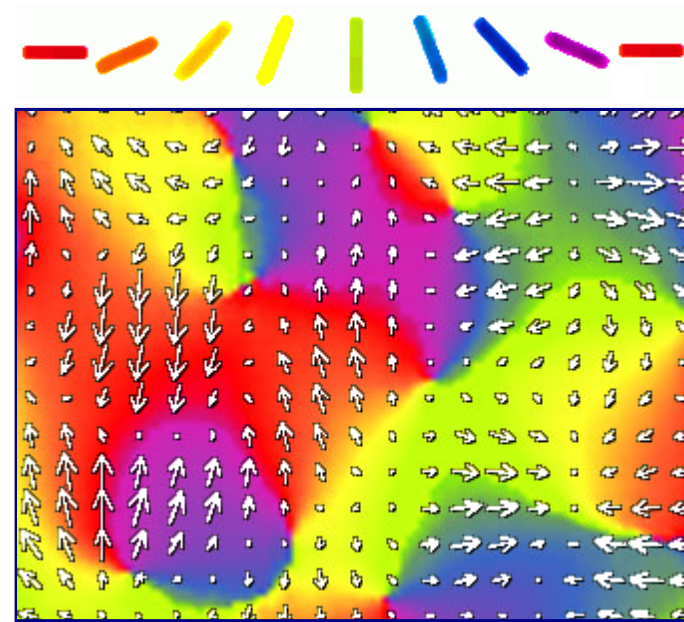

OR/Direction pref.

(1 × 1.4mm)

- Local patches prefer different directions
- Single-OR patches often subdivided by direction
- Other maps: spatial frequency, color, disparity

(Adult ferret; Weliky et al. 1996)

Cell-level organization

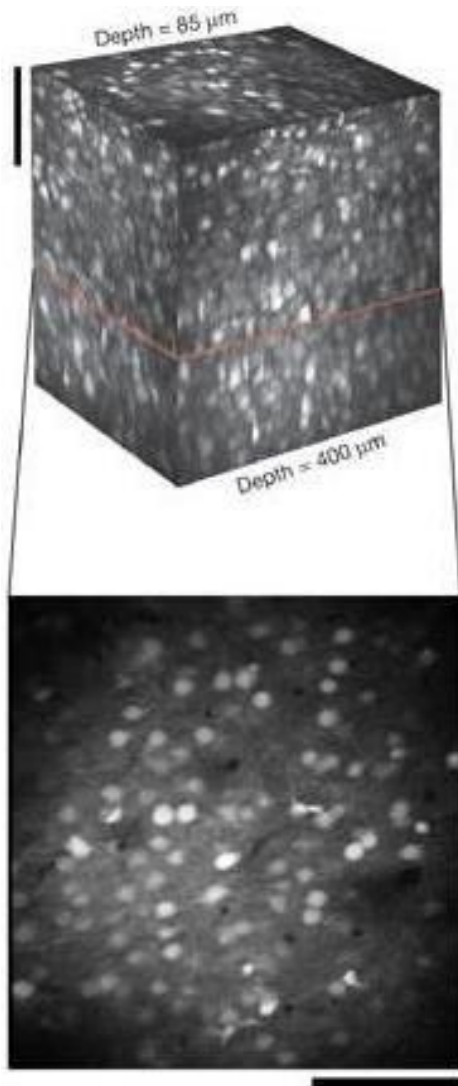

Rat V1 (scale bars 0.1mm)

Two-photon microscopy:

- New technique with cell-level resolution
- Can measure a small volume very precisely

(Ohki et al. 2005)

Cell-level organization 2

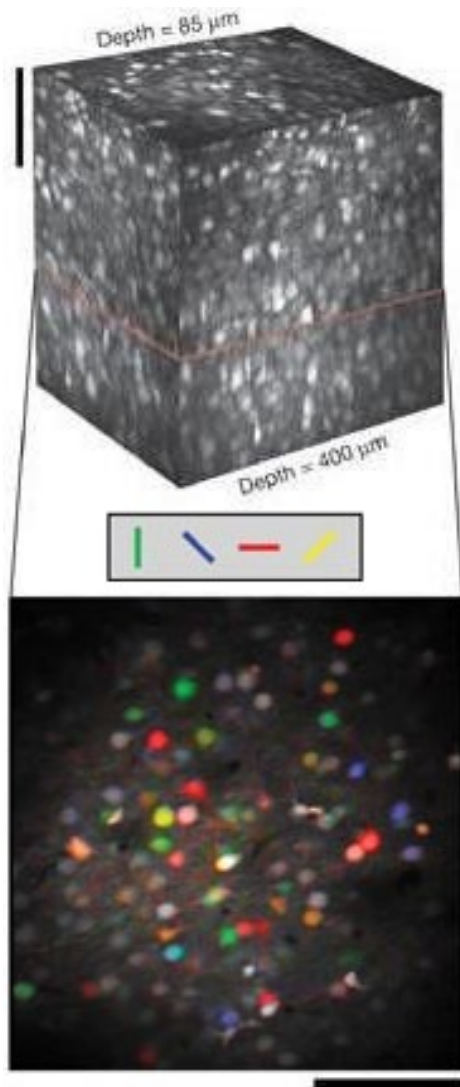

Rat V1 (scale bars 0.1mm)

- Individual cells can be tagged with feature preference
- In rat, orientation preferences are random
- Random also expected in mouse, squirrel

(Ohki et al. 2005)

Cell-level organization 3

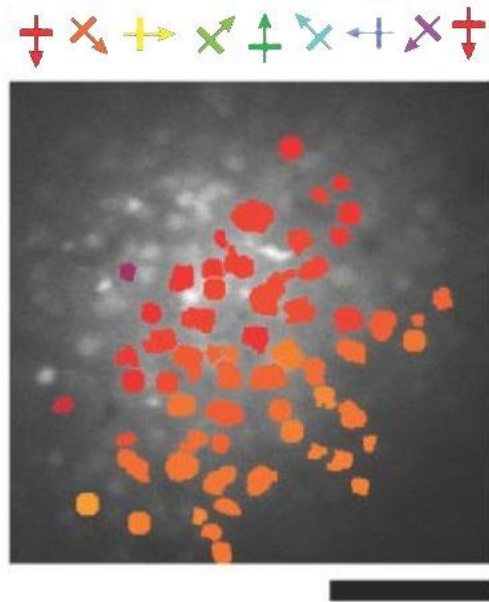

- In cat, validates results from optical imaging
- Smooth organization for direction overall
- Sharp, well-segregated discontinuities

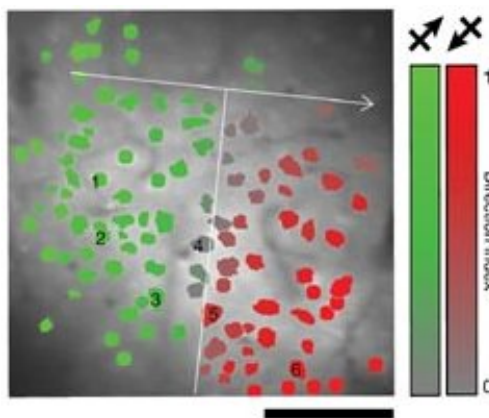

(Ohki et al. 2005)

Cat V1 Dir. (scale bars 0.1mm)

Cell-level organization 4

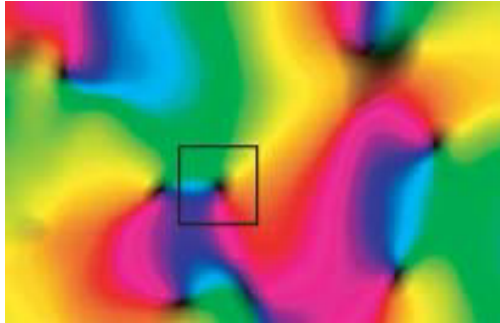

Low-res map ($2 \times 1.2\text{mm}$)

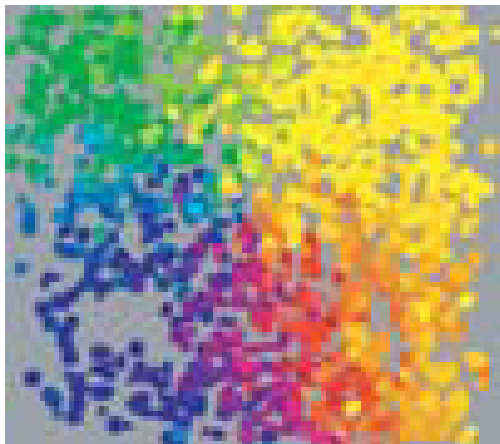

Stack of all labeled

cells ($0.6 \times 0.4\text{mm}$)

- Very close match with optical imaging results
- Stacking labeled cells from all layers shows very strong ordering spatially and in across layers
- Selectivity in pinwheels controversial; apparently lower

(Ohki et al. 2006)

Surround modulation

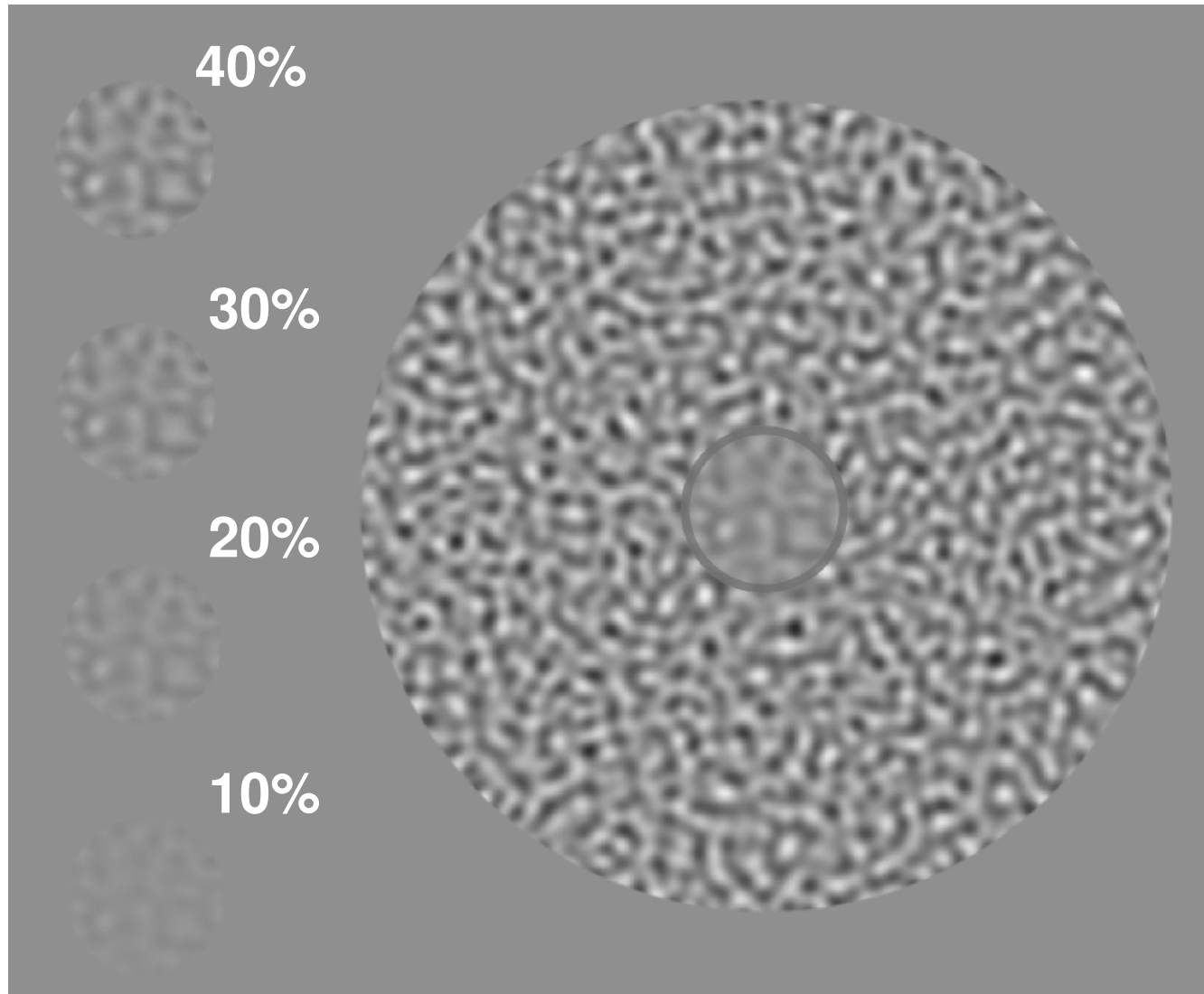

Which of the contrasts at left matches the central area?

Surround modulation

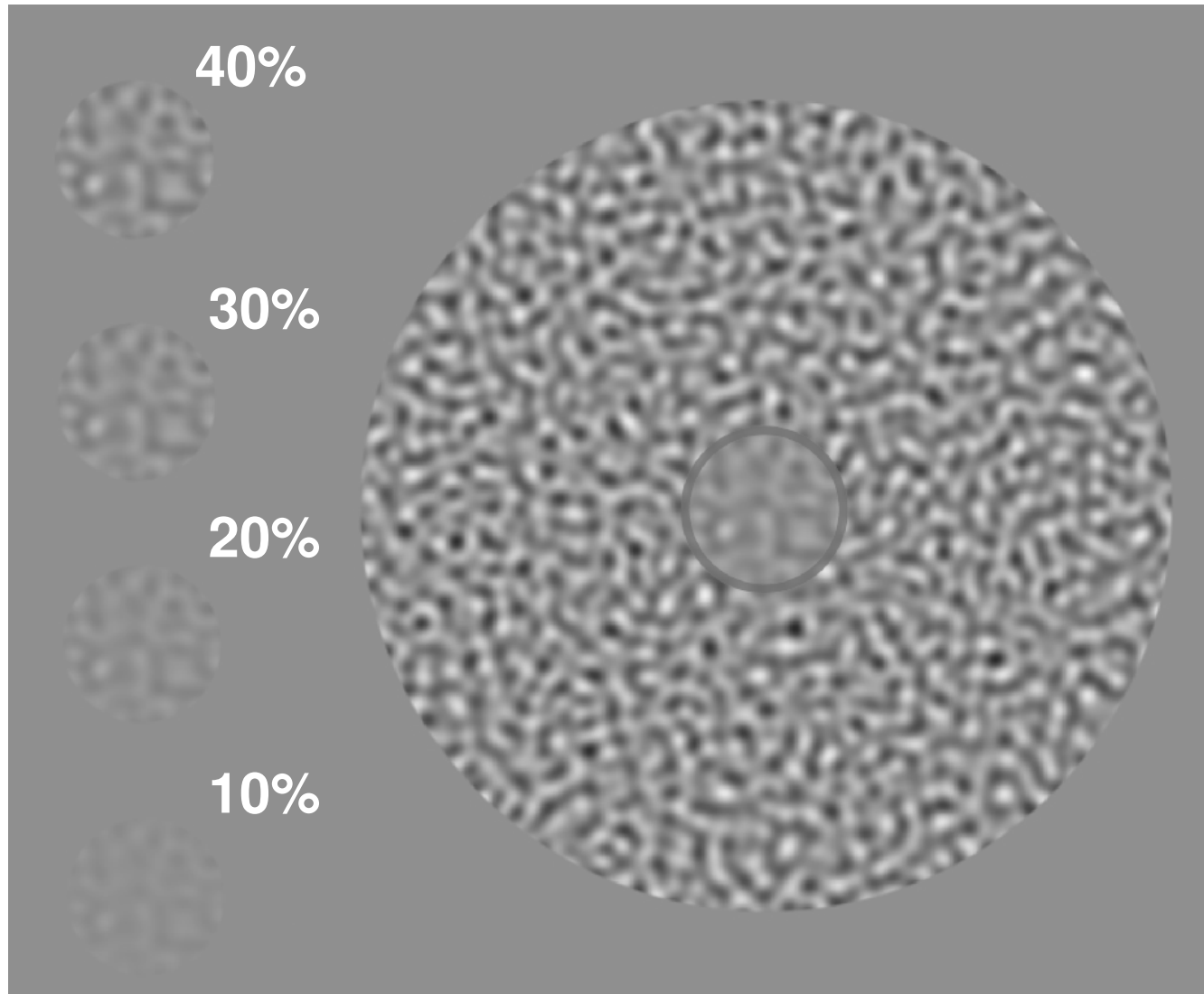

Which of the contrasts at left matches the central area? ^{40%}

Contextual interactions

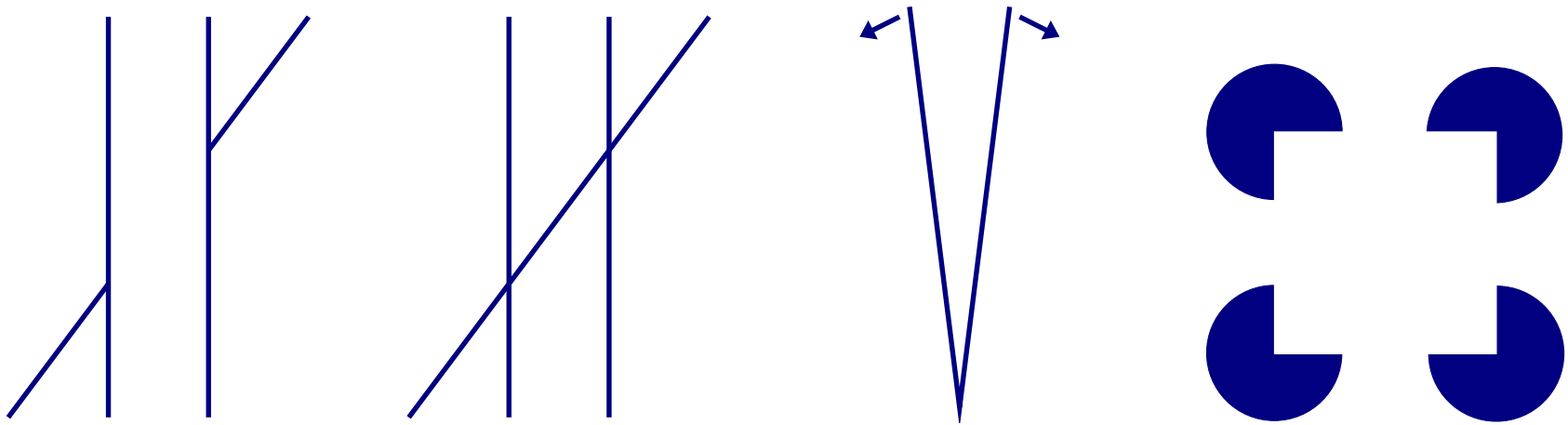

- Orientation and shape perception is not entirely local (e.g. due to individual V1 neurons).
- Instead, adjacent line elements interact (tilt illusion).
- Presumably due to lateral or feedback connections at V1 or above.

Lateral connections



(Macaque; Gilbert et al. 1990)

- Example layer 2/3 pyramidal cell
- Patchy every 1mm

Lateral connections

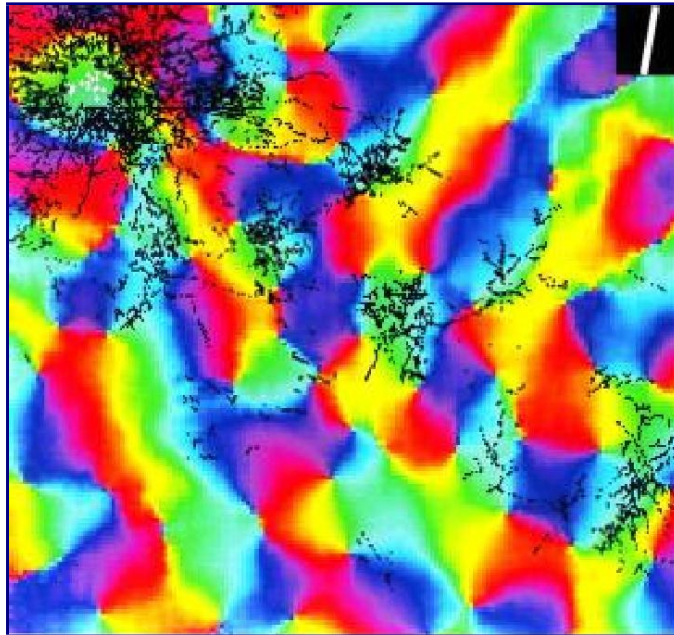

(2.5 mm × 2 mm in tree shrew V1; Bosking et al. 1997)

- Connections up to 8mm link to similar preferences
- Patchy structure, extend along OR preference

Feedback connections

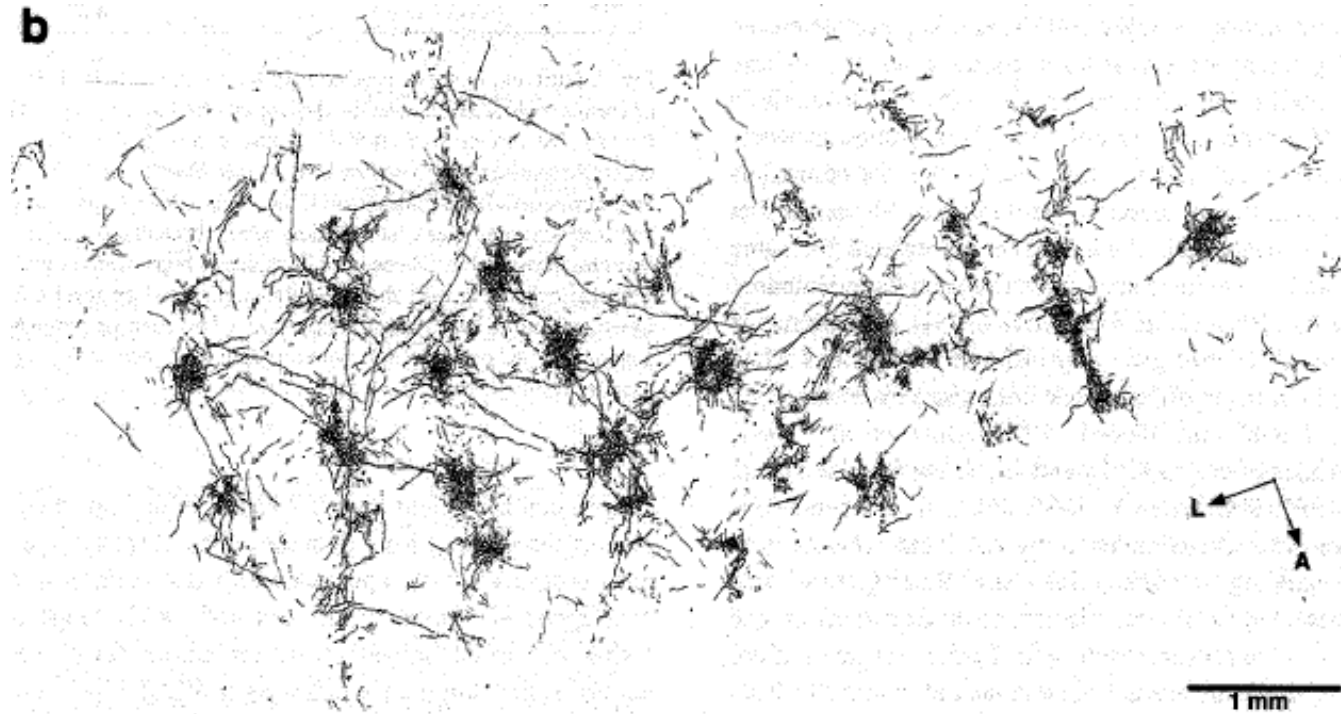

(Macaque; Angelucci et al. 2002)

- Relatively little known about feedback connections
- Large number, wide spread
- Some appear to be diffuse
- Some are patchy and orientation-specific

Visual development

Research questions studied in this course:

- Where does the visual system structure come from?
- How much of the architecture is specific to vision?
- What influence does the environment have?
- How plastic is the system in the adult?

Most visual development studies focus on ferrets and cats, whose visual systems are very immature at birth.

Initial development

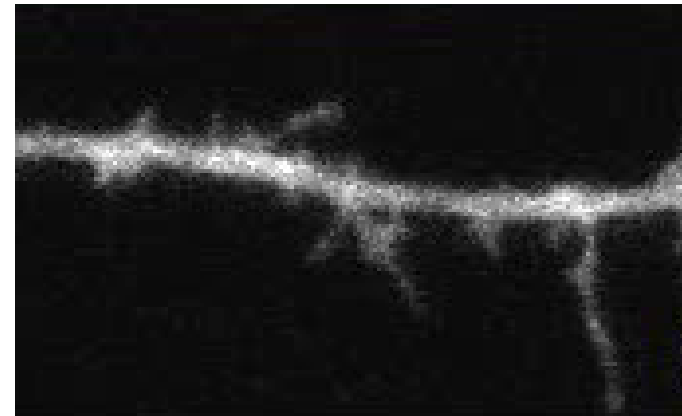

(Ziv 1996)

- Tissues develop into eye, brain
- RGC axons grow from eye to LGN and superior colliculus (SC) following chemical gradients
- Axons form synapses at LGN, SC
- LGN axons grow to V1, V2, etc., forming synapses

Cortical development

- Coarse cortical architecture (e.g. division into areas) appears to be fixed after birth
- Cortical architecture similar across areas
- Much of cortical development appears driven by different peripheral circuitry (auditory, visual, etc.)
- E.g. Sur et al. (1998-2000): auditory cortex can develop into visual cortex

Rewired ferrets

Sur et al. 1988-2000:

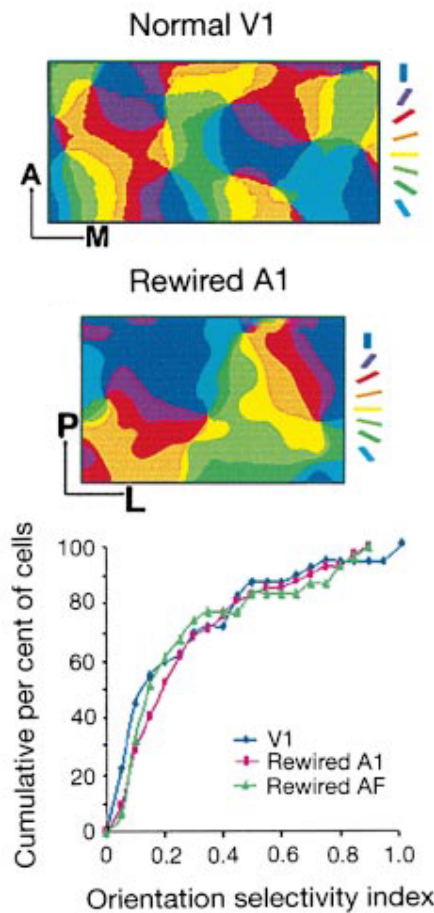
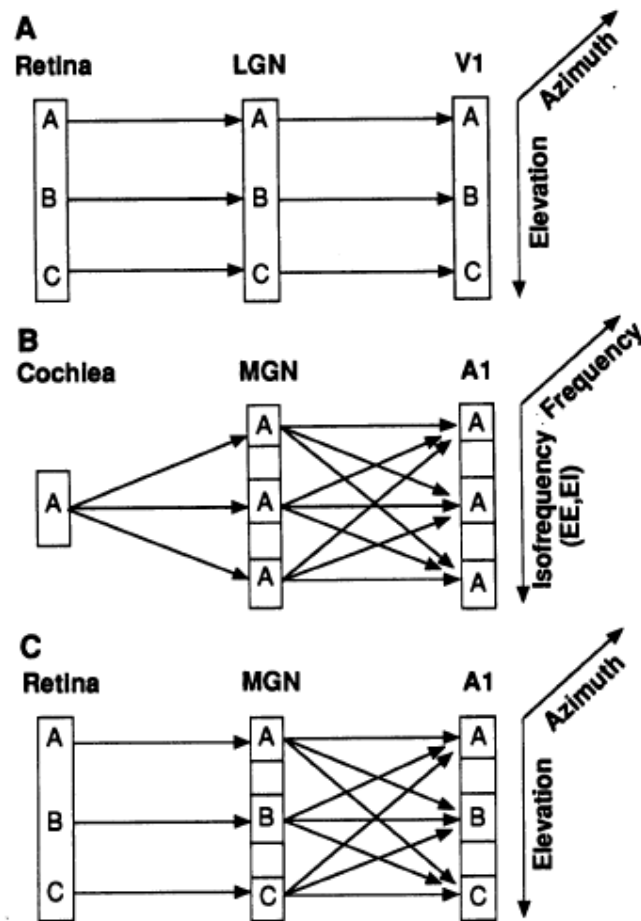

1. Disrupt connections to MGN
2. RGC axons now terminate in MGN
3. Then to A1 instead of V1
4. ~ Functional orientation cells, map in A1

Human visual system at birth

- Some visual ability
- Fovea barely there
- Color vision poor
- Binocular vision difficult
 - Poor control of eye movements
 - Seems to develop later
- Acuity increases 25X (birth to 6 months)

Map development

- Initial orientation, OD maps develop without visual experience (Crair et al. 1998)
 - Maps match between the eyes even without shared visual experience (Kim & Bonhoeffer 1994)
 - Experience leads to more selective neurons and maps (Crair et al. 1998)
 - Lid suture (leaving light through eyelids) during critical period destroys maps (White et al. 2001)
- ~> Complicated interaction between system and environment.

OR map development

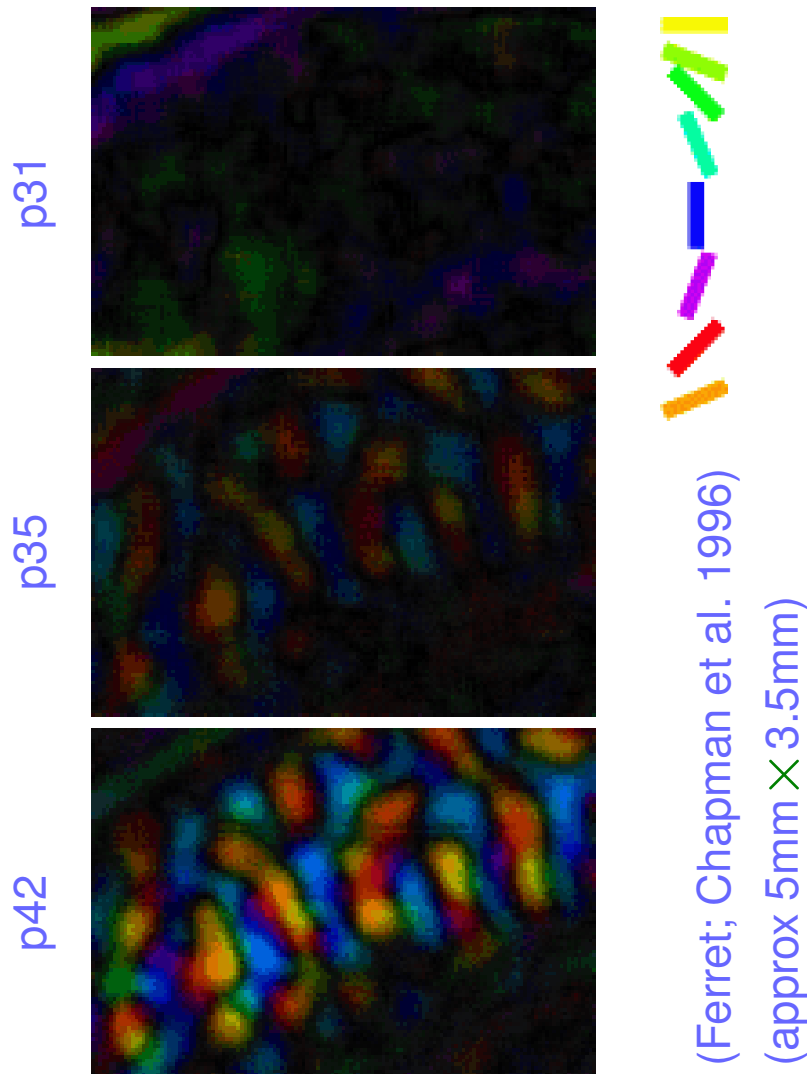

- Map not visible when eyes first forced open
- Gradually becomes stronger over weeks
- Shape doesn't change significantly
- Initial development affected little by dark rearing

Monocular deprivation

(Monkey V1 layer 4C; Wiesel 1982)

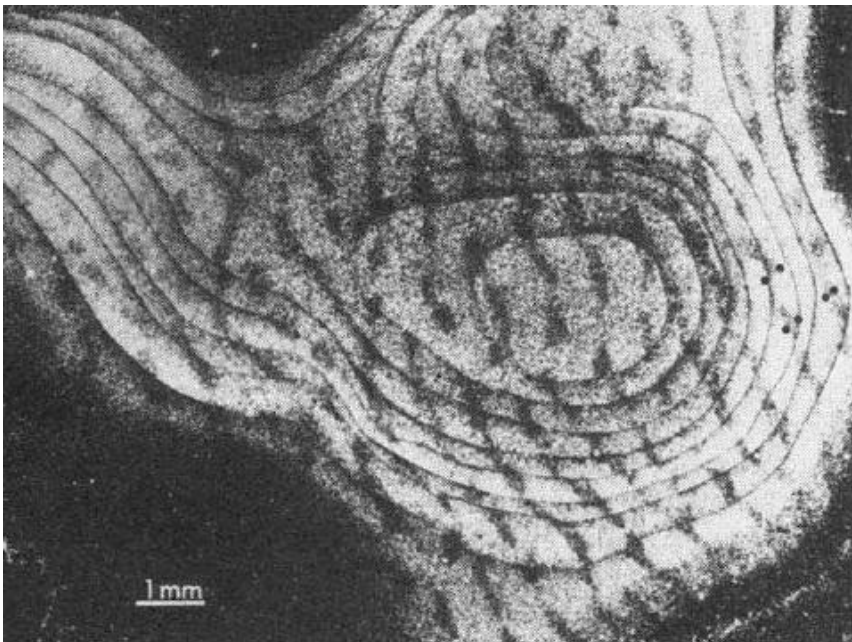

(Left eye (open) labeled white)

- Raising with one eyelid sutured shut results in larger area for other eye
- Sengpiel et al. 1999: Area for overrepresented orientations increases too

Internally generated inputs

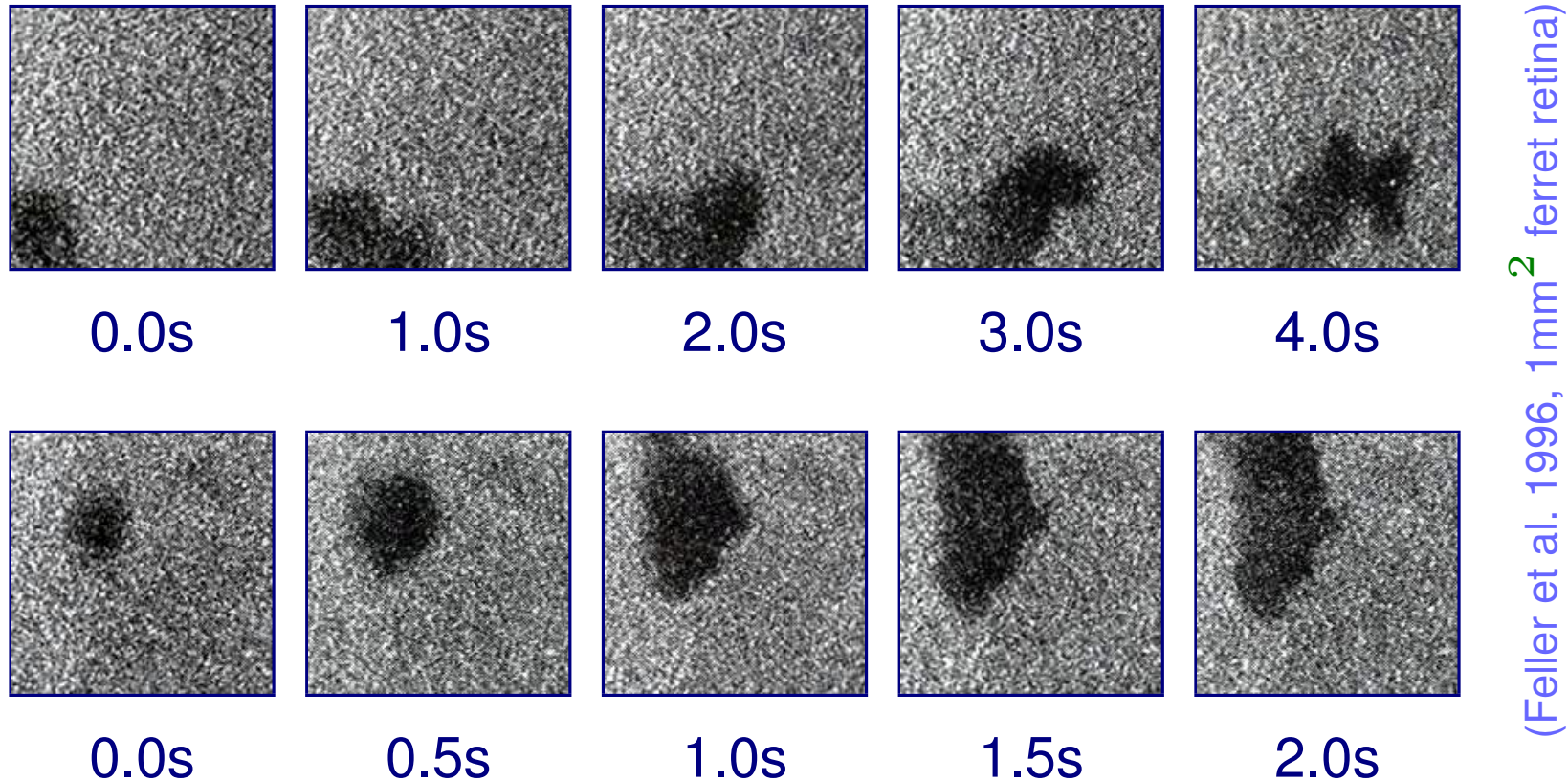

- Retinal waves: drifting patches of spontaneous activity
- Training patterns?

Role of spontaneous activity

- Silencing of retinal waves prevents eye-specific segregation in LGN (Huberman et al. 2003) and ocular dominance columns in V1 (Huberman et al. 2006)
- Boosting in one eye disrupts LGN, but not if in both
- Disrupting retinal waves disrupts geniculocortical mapping (Cang et al. 2005)
- Other sources of input to V1: spontaneous cortical activity, brainstem activity
- All developing areas seem to be spontaneously active, e.g. auditory system, spinal cord

Timeline: Cat

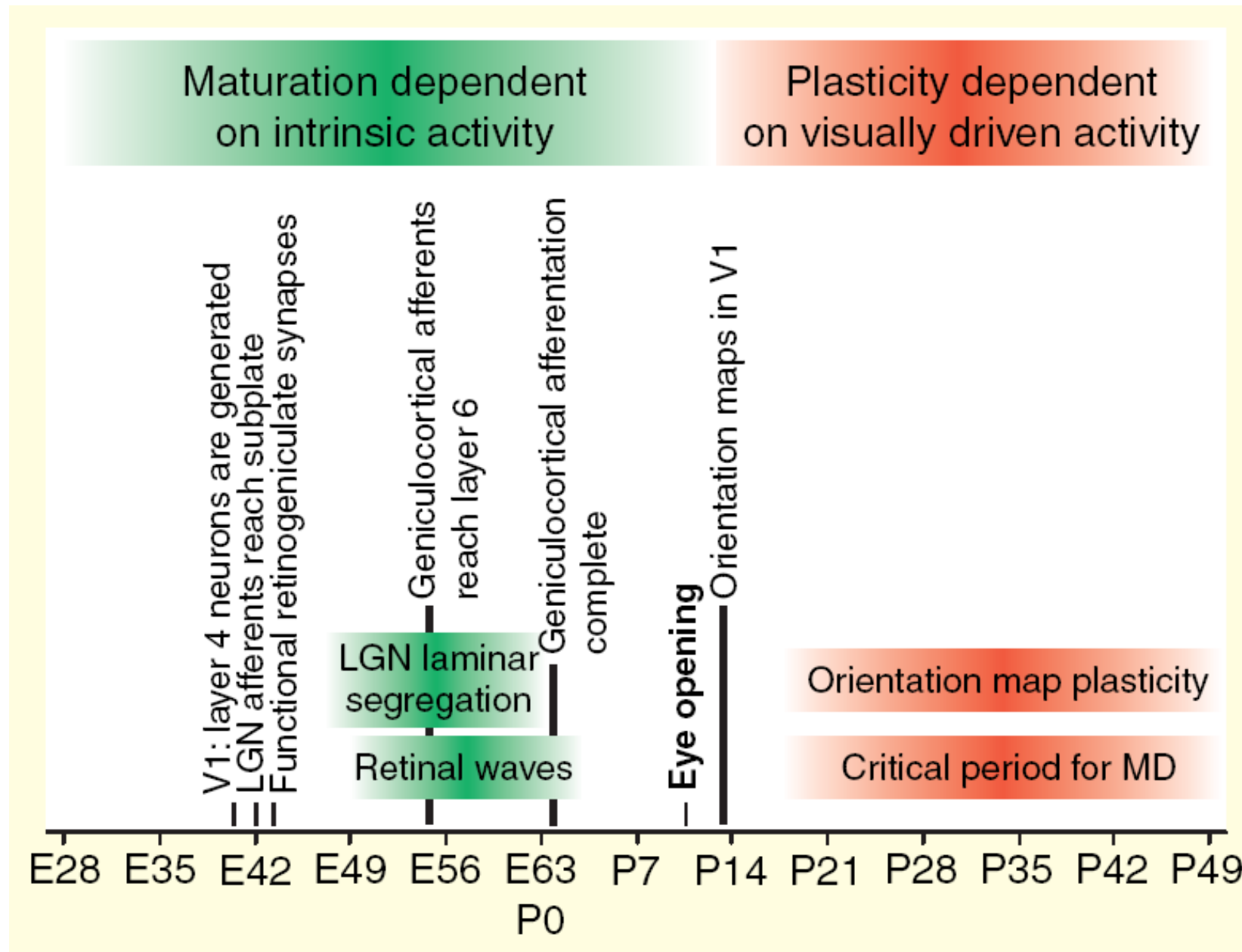

(Sengpiel & Kind 2002)

Timeline: Ferret

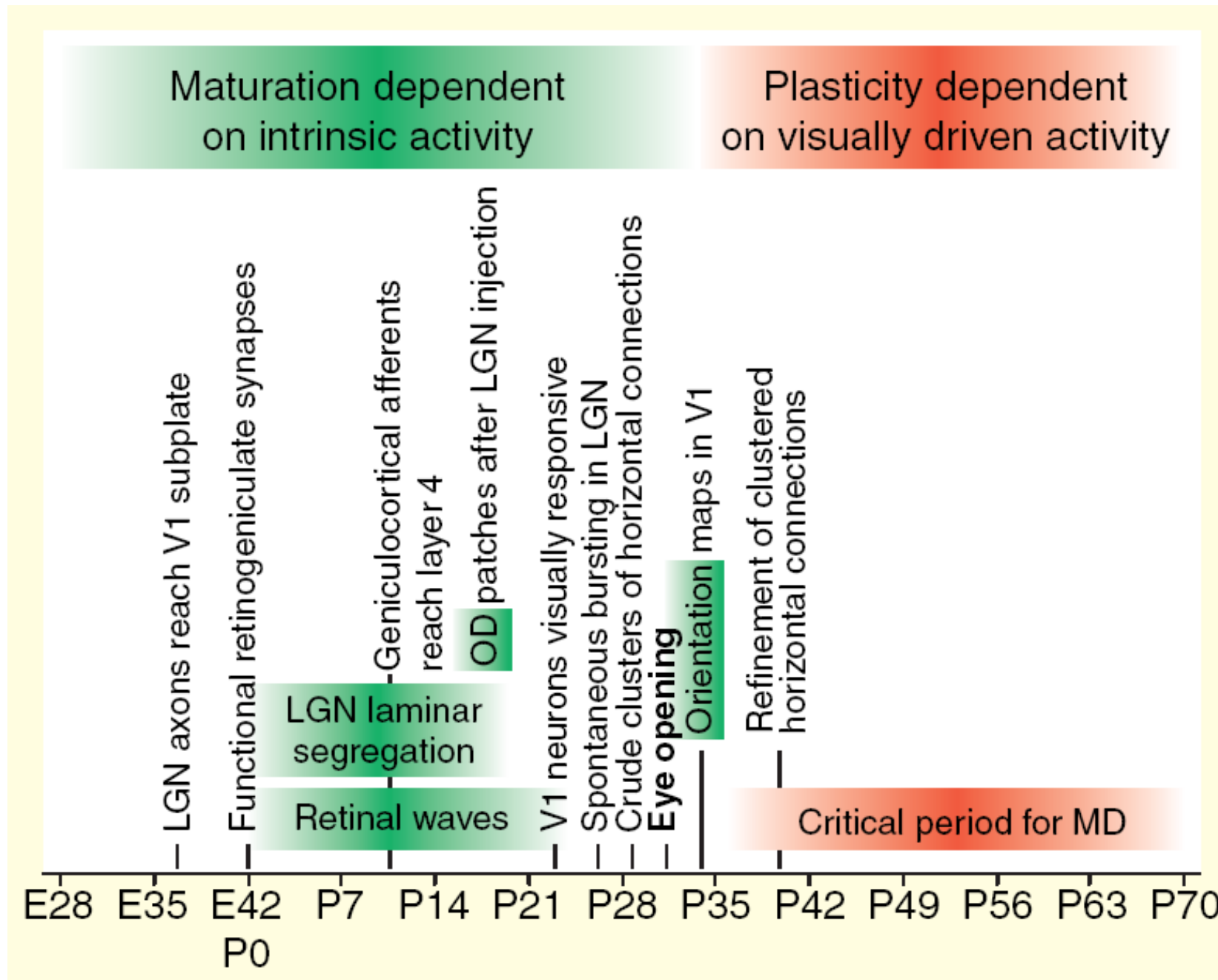

(Sengpiel & Kind 2002)

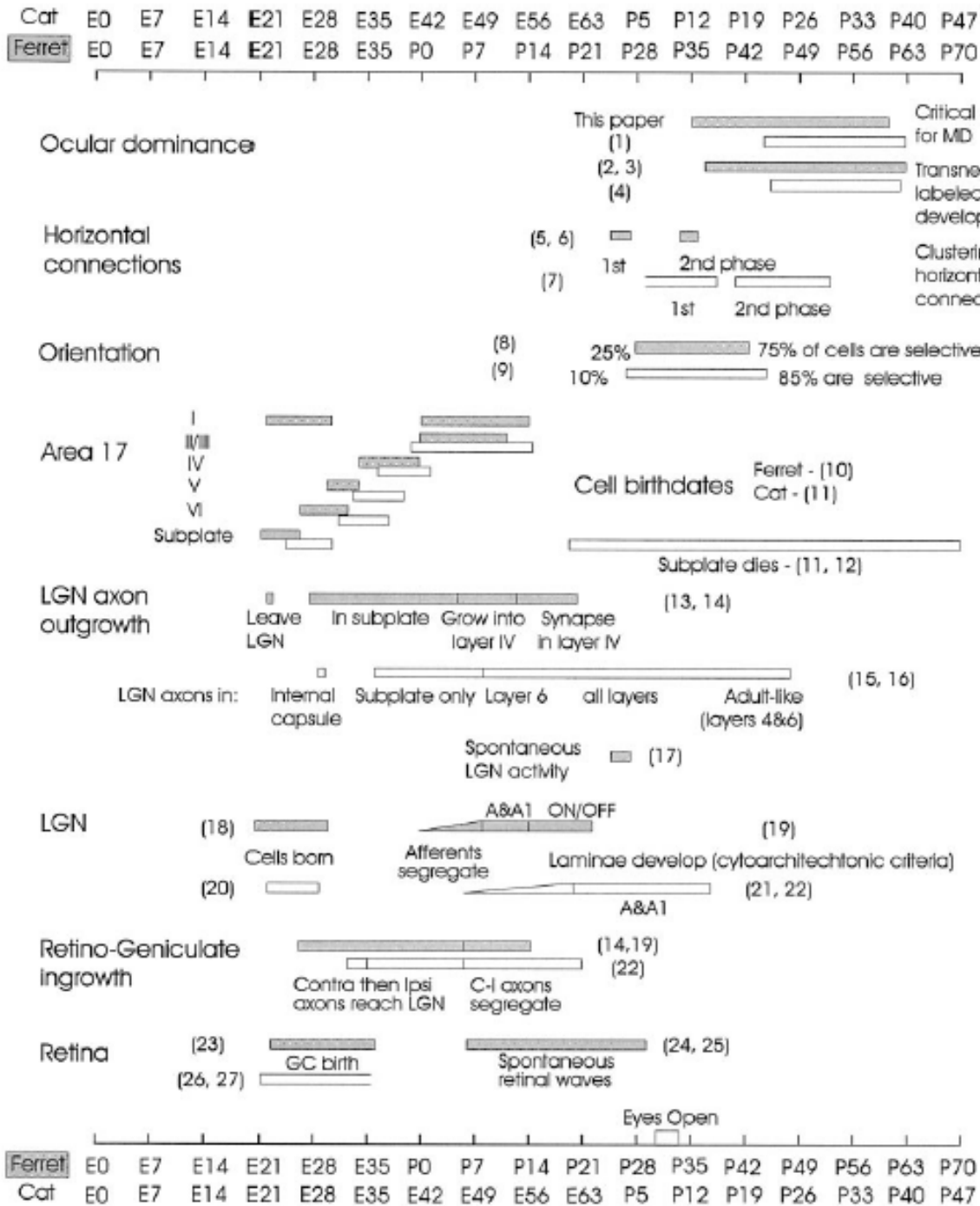

Cat vs. ferret

Should be readable in a printout, not on screen

OD, Ocular dominance
 MD, monocular deprivation
 GC, ganglion cell
 C-I, contralateral-ipsilateral

(Issa et al. 1999)

Ferret vs. mouse

Ferret

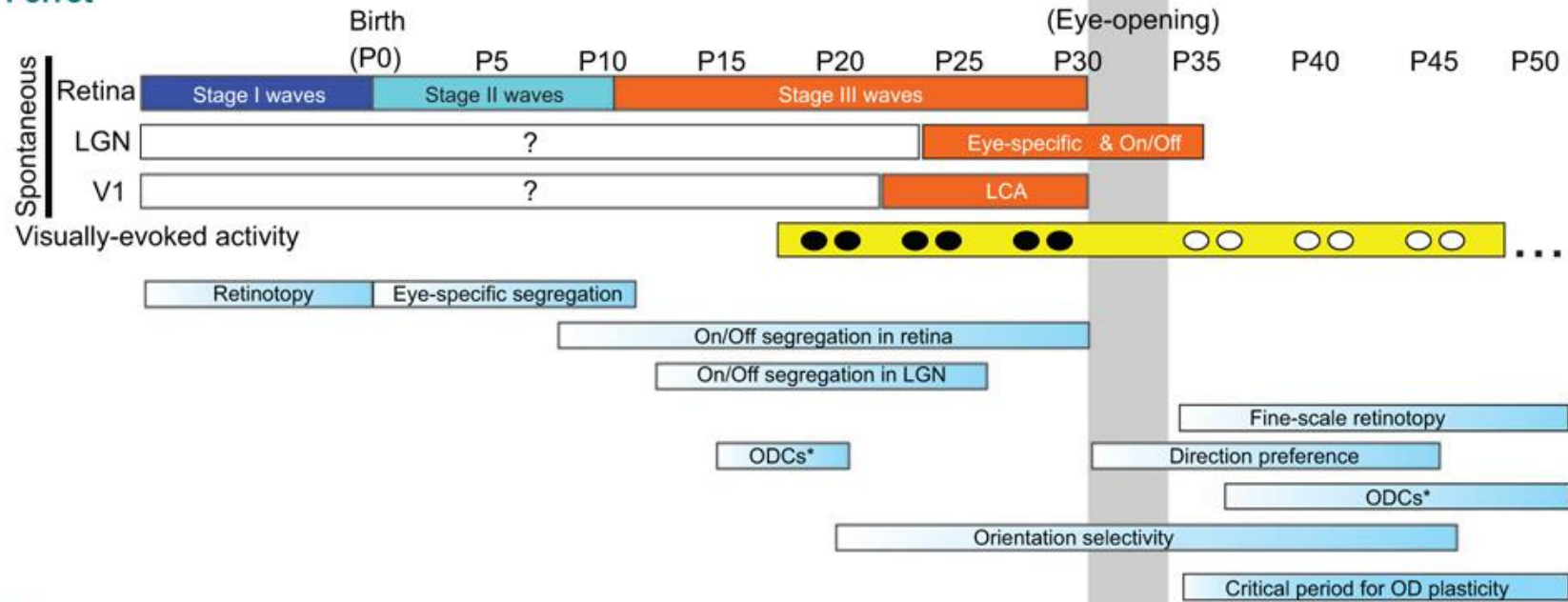

Mouse

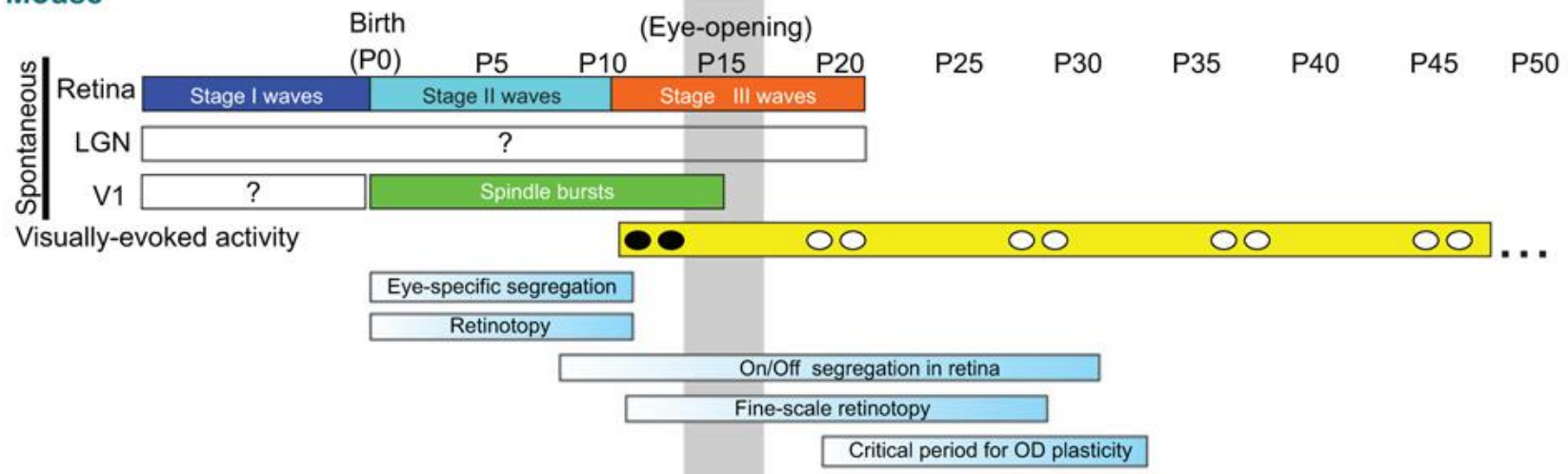

(Huberman et al. 2008)

Conclusions

- Early areas well studied
- Higher areas much less so
- Little understanding of how entire system works together
- Development also a mystery
- Lots of work to do

References

- Ahnelt, P. K., & Kolb, H. (2000). The mammalian photoreceptor mosaic—adaptive design. *Progress in Retinal and Eye Research*, 19 (6), 711–777.
- Angelucci, A., Levitt, J. B., & Lund, J. S. (2002). Anatomical origins of the classical receptive field and modulatory surround field of single neurons in macaque visual cortical area V1. *Progress in Brain Research*, 136, 373–388.
- Bosking, W. H., Crowley, J. C., & Fitzpatrick, D. (2002). Spatial coding of position and orientation in primary visual cortex. *Nature Neuroscience*, 5 (9), 874–882.
- Bosking, W. H., Zhang, Y., Schofield, B. R., & Fitzpatrick, D. (1997). Orientation selectivity and the arrangement of horizontal connections in tree shrew striate cortex. *The Journal of Neuroscience*, 17 (6), 2112–2127.

- Cang, J., Renteria, R. C., Kaneko, M., Liu, X., Copenhagen, D. R., & Stryker, M. P. (2005). Development of precise maps in visual cortex requires patterned spontaneous activity in the retina. *Neuron*, *48* (5), 797–809.
- Chapman, B., Stryker, M. P., & Bonhoeffer, T. (1996). Development of orientation preference maps in ferret primary visual cortex. *The Journal of Neuroscience*, *16* (20), 6443–6453.
- Crair, M. C., Gillespie, D. C., & Stryker, M. P. (1998). The role of visual experience in the development of columns in cat visual cortex. *Science*, *279*, 566–570.
- DeAngelis, G. C., Ghose, G. M., Ohzawa, I., & Freeman, R. D. (1999). Functional micro-organization of primary visual cortex: Receptive field analysis of nearby neurons. *The Journal of Neuroscience*, *19* (10), 4046–4064.
- Feller, M. B., Wellis, D. P., Stellwagen, D., Werblin, F. S., & Shatz, C. J. (1996).

Requirement for cholinergic synaptic transmission in the propagation of spontaneous retinal waves. *Science*, 272, 1182–1187.

Gilbert, C. D., Hirsch, J. A., & Wiesel, T. N. (1990). Lateral interactions in visual cortex. In *The Brain* (Vol. LV of *Cold Spring Harbor Symposia on Quantitative Biology*, pp. 663–677). Cold Spring Harbor, NY: Cold Spring Harbor Laboratory Press.

Hubel, D. H., & Wiesel, T. N. (1977). Functional architecture of macaque visual cortex. *Proceedings of the Royal Society of London Series B*, 198, 1–59.

Huberman, A. D., Feller, M. B., & Chapman, B. (2008). Mechanisms underlying development of visual maps and receptive fields. *Annual Review of Neuroscience*, 31, 479–509.

Huberman, A. D., Speer, C. M., & Chapman, B. (2006). Spontaneous retinal

activity mediates development of ocular dominance columns and binocular receptive fields in V1. *Neuron*, 52 (2), 247–254.

Huberman, A. D., Wang, G. Y., Liets, L. C., Collins, O. A., Chapman, B., & Chalupa, L. M. (2003). Eye-specific retinogeniculate segregation independent of normal neuronal activity. *Science*, 300 (5621), 994–998.

Issa, N. P., Trachtenberg, J. T., Chapman, B., Zahs, K. R., & Stryker, M. P. (1999). The critical period for ocular dominance plasticity in the ferret's visual cortex. *The Journal of Neuroscience*, 19 (16), 6965–6978.

Kandel, E. R., Schwartz, J. H., & Jessell, T. M. (1991). *Principles of Neural Science* (3rd Ed.). Amsterdam: Elsevier.

Kim, D. S., & Bonhoeffer, T. (1994). Reverse occlusion leads to a precise restora-

tion of orientation preference maps in visual cortex. *Nature*, 370 (6488), 370–372.

Ohki, K., Chung, S., Ch'ng, Y. H., Kara, P., & Reid, R. C. (2005). Functional imaging with cellular resolution reveals precise micro-architecture in visual cortex. *Nature*, 433 (7026), 597–603.

Ohki, K., Chung, S., Kara, P., Hubener, M., Bonhoeffer, T., & Reid, R. C. (2006). Highly ordered arrangement of single neurons in orientation pinwheels. *Nature*, 442 (7105), 925–928.

Sclar, G., & Freeman, R. D. (1982). Orientation selectivity in the cat's striate cortex is invariant with stimulus contrast. *Experimental Brain Research*, 46, 457–461.

- Sengpiel, F., & Kind, P. C. (2002). The role of activity in development of the visual system. *Current Biology*, *12* (23), R818–R826.
- Sengpiel, F., Stawinski, P., & Bonhoeffer, T. (1999). Influence of experience on orientation maps in cat visual cortex. *Nature Neuroscience*, *2* (8), 727–732.
- Sur, M., Garraghty, P. E., & Roe, A. W. (1988). Experimentally induced visual projections in auditory thalamus and cortex. *Science*, *242*, 1437–1441.
- Van Essen, D. C., Anderson, C. H., & Felleman, D. J. (1992). Information processing in the primate visual system: An integrated systems perspective. *Science*, *255*, 419–423.
- Weliky, M., Bosking, W. H., & Fitzpatrick, D. (1996). A systematic map of direction preference in primary visual cortex. *Nature*, *379*, 725–728.

White, L. E., Coppola, D. M., & Fitzpatrick, D. (2001). The contribution of sensory experience to the maturation of orientation selectivity in ferret visual cortex. *Nature*, *411*, 1049–1052.

Wiesel, T. N. (1982). Postnatal development of the visual cortex and the influence of the environment. *Nature*, *299*, 583–591.